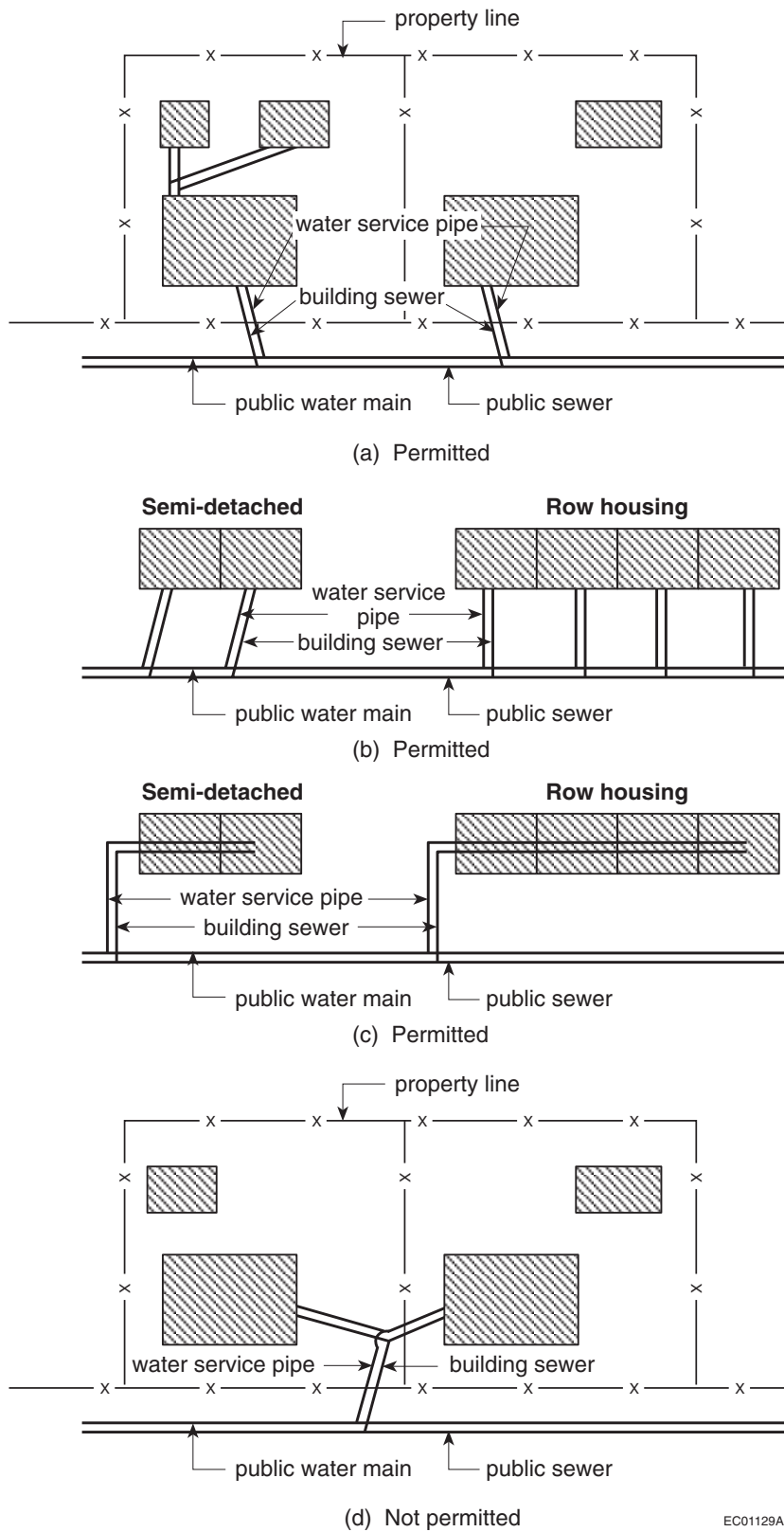


## Notes to Part 2

### Plumbing Systems

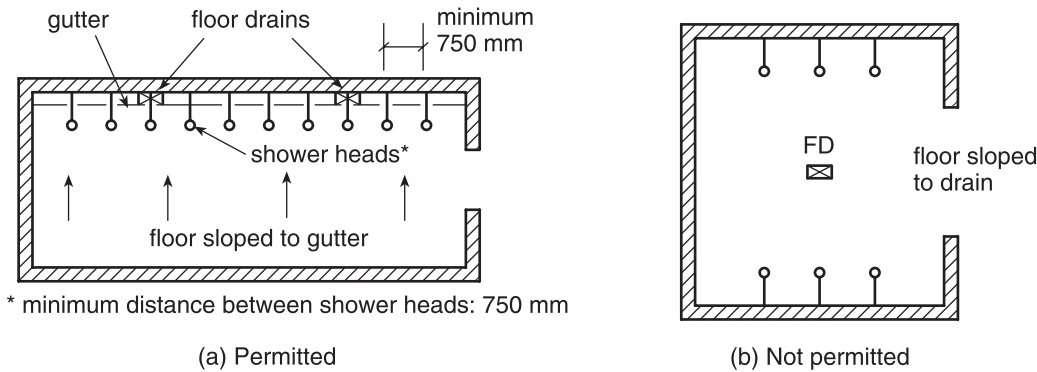
**A-2.1.2.1.(2) Combined Building Drains.** Combined building drains may have proven acceptable on the basis of past performance in some localities and their acceptance under this Code may be warranted.

**A-2.1.2.4.(1) Service Piping.** The layout as shown in Figure A-2.1.2.4.(1)(c) may require special legal arrangements in some jurisdictions to ensure that access can be provided to all parts of the service pipes.



**Figure A-2.1.2.4.(1)**  
**Service Piping**

**A-2.2.2.3.(3) Shower Drainage (Plan View).**

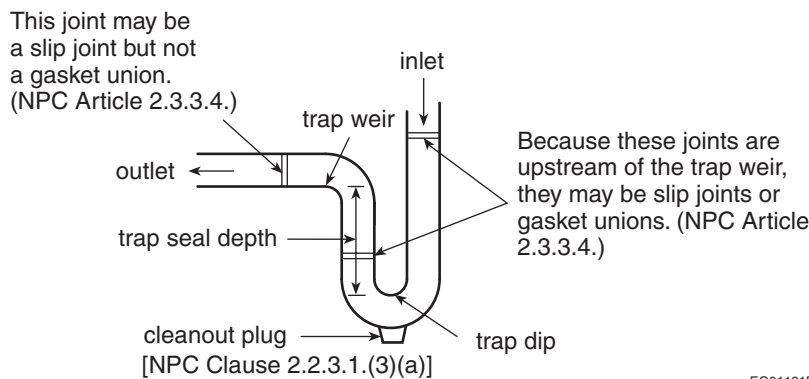


EG01130B

**Figure A-2.2.2.3.(3) Shower Drainage (Plan View)**

**A-2.2.2.4.(1) Concealed Overflows.** The use of concealed overflows does not preclude the use of a standing waste.

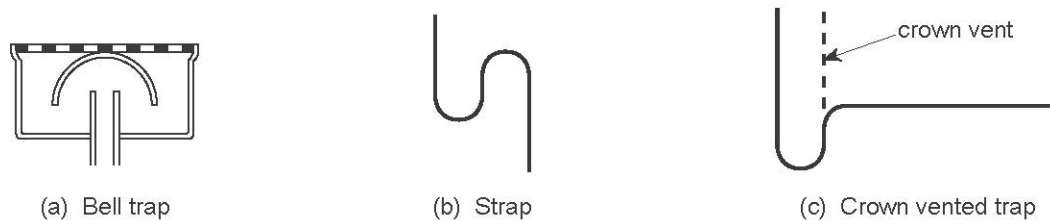
**A-2.2.3.1.(1) and (3) Trap Seal Depth and Trap Connections.**



EG01131B

**Figure A-2.2.3.1.(1) and (3) Trap Seal Depth and Trap Connections**

**A-2.2.3.1.(4) Prohibited Traps.** Except for an S-trap standard, the S trap shown in Figure A-2.2.3.1.(4)(b) is prohibited by Clause 2.5.6.3.(1)(b), which limits the fall on fixture drains. Crown vented traps shown in Figure A-2.2.3.1.(4)(c) are prohibited by Clause 2.5.6.3.(1)(a), which requires that the distance from the trap weir to the vent be not less than twice the size of the fixture drain.

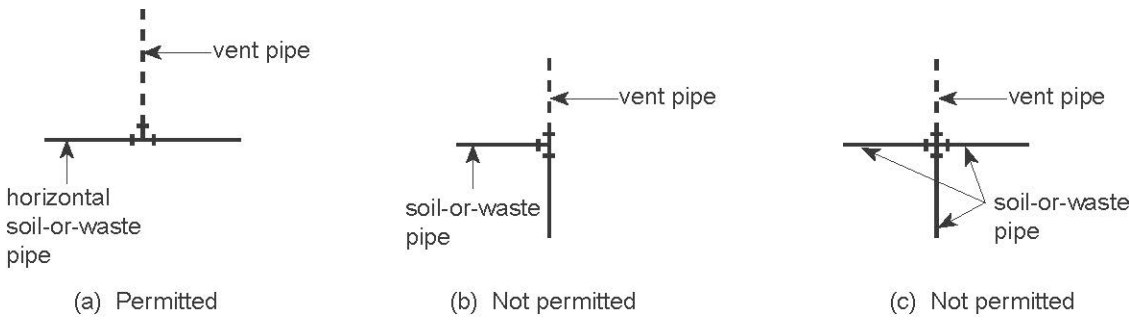


EG01132A

**Figure A-2.2.3.1.(4) Prohibited Traps**

**A-2.2.3.2.(3) Grease Interceptors.** CSA B481.4, “Maintenance of Grease Interceptors,” is considered to represent good practice regarding procedures for the maintenance of grease interceptors.

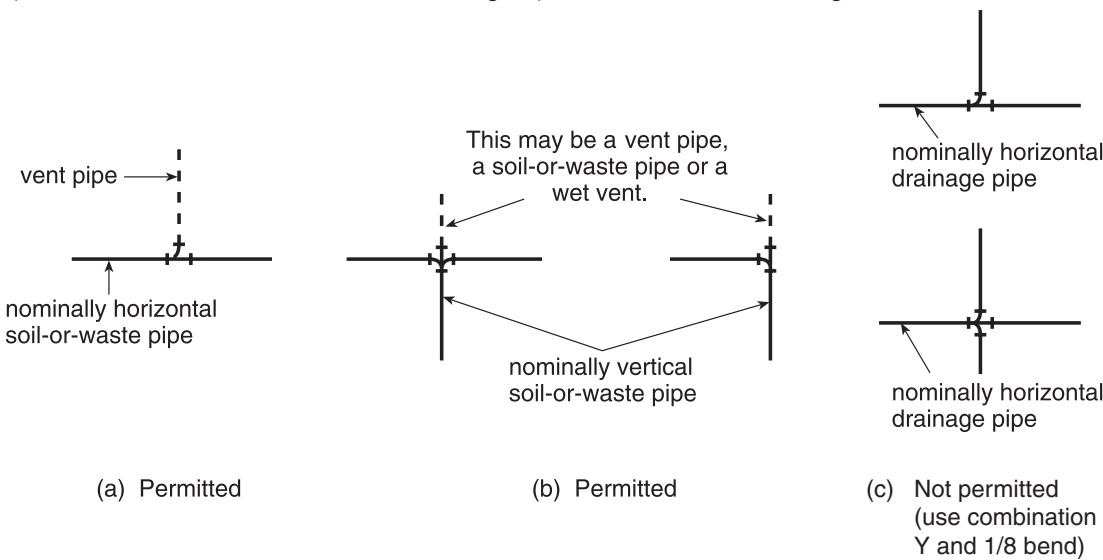
**A-2.2.4.1. T Fittings in Drainage Systems.** The use of a cross fitting in a drainage system is prohibited, but such fitting may be used in a venting system to connect 4 vent pipes. In a drainage system, a T fitting can only be used as shown in Figure A-2.2.4.1.(a), and cannot be used as shown in Figure A-2.2.4.1.(b) because the T or cross fitting would change the direction of flow in the drainage system.



EG01133B

**Figure A-2.2.4.1.**  
**T Fittings in Drainage Systems**

**A-2.2.4.2. Sanitary T Fittings in Drainage Systems.** A sanitary T fitting may be used to change the direction of flow in a drainage system from horizontal to vertical, but may not be used to change the direction of flow in a nominally horizontal drainage system. A combination Y and 1/8th bend fitting may also be used as shown in Figure A-2.2.4.2.(b).



EG01134A

**Figure A-2.2.4.2.**  
**Sanitary T Fittings in Drainage Systems**

**A-2.2.5., 2.2.6. and 2.2.7. Pipe and Fitting Applications.**

**Table A-2.2.5., 2.2.6. and 2.2.7.**  
**Summary of Pipe and Fitting Applications**  
Forming Part of Note A-2.2.5., 2.2.6. and 2.2.7.

Types of Piping and Fittings	Standard References	NPC References	Use of Piping and Fittings <sup>(1)</sup>									
			Drainage System			Venting System		Potable Water System				
			Above-ground inside building	Under-ground under building	Building sewer	Above-ground	Under-ground	Aboveground		Underground		
								Cold	Hot	Under building	Outside building	
Fibrocement DWV pipe  Type 1, Class 3000 and Type 2, Class 4000	CAN/CSA-B127.3-18	2.2.5.1.(1)	P	P	P	P	P	N	N	N	N	

Rev. 12717

**Table A-2.2.5., 2.2.6. and 2.2.7. (continued)**  
**Summary of Pipe and Fitting Applications**  
 Forming Part of Note A-2.2.5., 2.2.6. and 2.2.7.

Types of Piping and Fittings	Standard References	NPC References	Use of Piping and Fittings <sup>(1)</sup>									
			Drainage System			Venting System		Potable Water System				
			Above-ground inside building	Under-ground under building	Building sewer	Above-ground	Under-ground	Aboveground		Underground		
								Cold	Hot	Under building	Outside building	
Concrete sewer pipe	CSA Series A257											
Sewer, storm drain and culvert	CSA A257.1	2.2.5.2.	N	P <sup>(2)</sup>	P	N	N	N	N	N	N	N
Reinforced culvert, storm drain and sewer	CSA A257.2	2.2.5.2.	N	P <sup>(2)</sup>	P	N	N	N	N	N	N	N
Vitrified clay pipe	CSA A60.1-M	2.2.5.3.	N	P	P	N	P	N	N	N	N	N
Polyethylene water pipe and tubing												
Series 160 sizes with compression fittings	CAN/CSA-B137.1	2.2.5.4.	N	N	N	N	N	N	N	P <sup>(3)</sup>	P <sup>(3)</sup>	
Series 50, 75, 100 and 125		2.2.5.4.	N	N	N	N	N	N	N	N	N	N
Polyethylene (PE) plastic pipe (SDR-PR) based on outside diameter	ASTM F 714	2.2.5.5.(1)	N	P	P	N	P	N	N	N	N	N
Polyvinyl chloride (PVC) pressure fittings	CAN/CSA-B137.2	2.2.5.7.	N	N	N	N	N	P <sup>(4)(5)</sup>	N	P	P	
Polyvinyl chloride (PVC) water pipe												
Dimension ratios (DR) or standard dimension ratios (SDR) 14, 17, 18, 21, 25 and 26	CAN/CSA-B137.3	2.2.5.7.	N	N	N	N	N	P	N	P <sup>(6)</sup>	P <sup>(6)</sup>	
Schedule 40 in sizes from ½ inch to 2½ inches inclusively												
Schedule 80 in sizes from ½ inch to 6 inches inclusively												
PVC fittings, Schedule 40	ASTM D 2466	2.2.5.7.(2)	N	N	N	N	N	P <sup>(4)(5)</sup>	N	N	N	N

**Table A-2.2.5., 2.2.6. and 2.2.7. (continued)**  
**Summary of Pipe and Fitting Applications**  
 Forming Part of Note A-2.2.5., 2.2.6. and 2.2.7.

Types of Piping and Fittings	Standard References	NPC References	Use of Piping and Fittings <sup>(1)</sup>								
			Drainage System			Venting System		Potable Water System			
			Above-ground inside building	Under-ground under building	Building sewer	Above-ground	Under-ground	Aboveground		Underground	
								Cold	Hot	Under building	Outside building
PVC fittings, Schedule 80	ASTM D 2467	2.2.5.7.(2)	N	N	N	N	N	P <sup>(4)(5)</sup>	N	P	P
Crosslinked polyethylene (PEX) pressure tubing	CAN/CSA-B137.5	2.2.5.6.	N	N	N	N	N	P <sup>(4)(5)</sup>	P <sup>(4)(5)</sup>	P	P
Chlorinated polyvinyl chloride (CPVC) water pipe	CAN/CSA-B137.6	2.2.5.8.	N	N	N	N	N	P <sup>(4)(5)(7)</sup>	P <sup>(4)(5)(7)</sup>	P <sup>(7)</sup>	P <sup>(7)</sup>
Polyethylene/Aluminum/Polyethylene (PE/AL/PE) pressure pipe	CAN/CSA-B137.9	2.2.5.12.	N	N	N	N	N	P <sup>(4)(5)</sup>	N	P	P
Crosslinked Polyethylene/Aluminum/Crosslinked Polyethylene (PEX/AL/PEX) pressure pipe	CAN/CSA-B137.10	2.2.5.13.	N	N	N	N	N	P <sup>(4)(5)</sup>	P <sup>(4)(5)</sup>	P	P
Polypropylene (PP-R) pressure pipe	CAN/CSA-B137.11	2.2.5.14.	N	N	N	N	N	P <sup>(4)(5)</sup>	P <sup>(4)(5)</sup>	P	P
Plastic sewer pipe PS ≥ 320 kPa	CAN/CSA-B182.1	2.2.5.9.	N	P	P	N	N	N	N	N	N
Acrylonitrile-butadiene-styrene (ABS) DWV pipe	CAN/CSA-B181.1	2.2.5.9.	P <sup>(4)(5)</sup>	P	P	P <sup>(4)(5)</sup>	P	N	N	N	N
		2.2.5.10.									
ABS Schedule 40 DWV pipe with a cellular core	ASTM F 628	2.2.5.9.	P <sup>(4)(5)</sup>	P	P	P <sup>(4)(5)</sup>	P	N	N	N	N
Polyvinyl chloride (PVC) DWV pipe	CAN/CSA-B181.2	2.2.5.9.	P <sup>(4)(5)</sup>	P	P	P <sup>(4)(5)</sup>	P	N	N	N	N
		2.2.5.10.									
PVC sewer pipe (PSM type) ≤ 35-SDR	CAN/CSA-B182.2	2.2.5.9.	N	P	P	N	P	N	N	N	N
Profile polyvinyl chloride (PVC) sewer pipe PS ≥ 320 kPa	CAN/CSA-B182.4	2.2.5.9.(1)(f)	N	P	P	N	P	N	N	N	N

**Table A-2.2.5., 2.2.6. and 2.2.7. (continued)**  
**Summary of Pipe and Fitting Applications**  
 Forming Part of Note A-2.2.5., 2.2.6. and 2.2.7.

Types of Piping and Fittings	Standard References	NPC References	Use of Piping and Fittings <sup>(1)</sup>								
			Drainage System			Venting System		Potable Water System			
			Above-ground inside building	Under-ground under building	Building sewer	Above-ground	Under-ground	Aboveground		Underground	
								Cold	Hot	Under building	Outside building
Profile polyethylene sewer pipe PS ≥ 320 kPa	CAN/CSA-B182.6	2.2.5.9. (1)(g)	N	P	P	N	P	N	N	N	N
Polyolefin laboratory drainage systems	CAN/CSA-B181.3	2.2.8.1.	P <sup>(4)(5)</sup>	P	P	P <sup>(4)(5)</sup>	P	N	N	N	N
Cast-iron soil pipe	CSA B70	2.2.6.1.	P	P	P	P	P	N	N	N	N
Cast-iron water pipe	ANSI/AWWA C151/A21.51 (Ductile iron)	2.2.6.5.	P	P	P	P	P	P	P	P	P
Cast-iron screwed fittings	ASME B16.4 (Cast iron)	2.2.6.6.	N	N	N	N	N	P	P	P	P
	ASME B16.3 (Malleable iron)	2.2.6.7.	N	N	N	N	N	P	P	P	P
Stainless steel pipe	ASTM A 312/A 312M	2.2.6.11.	P	P	P	P	P	P	P	P	P
Stainless steel tube	ASTM A 269	2.2.6.15.	N	N	N	N	N	P	P	P	P
Welded and seamless steel galvanized pipe	ASTM A 53/A 53M	2.2.6.8.	P	N	N	P	N	P <sup>(8)</sup>	P <sup>(8)</sup>	P <sup>(8)</sup>	P <sup>(8)</sup>
Corrugated steel galvanized pipe	CSA G401	2.2.6.9.	N	N	P <sup>(9)</sup>	N	N	N	N	N	N
Sheet metal pipe <sup>(10)</sup>	—	2.2.6.10.	N	N	N	N	N	N	N	N	N
Copper and brass pipe	ASTM B 42 (Copper)	2.2.7.1.	P	P	P	P	P	P	P	P	P
	ASTM B 43 (Red brass)	2.2.7.1.	P	P	P	P	P	P	P	P	P

**Table A-2.2.5., 2.2.6. and 2.2.7. (continued)**  
**Summary of Pipe and Fitting Applications**  
 Forming Part of Note A-2.2.5., 2.2.6. and 2.2.7.

Types of Piping and Fittings	Standard References	NPC References	Use of Piping and Fittings <sup>(1)</sup>								
			Drainage System			Venting System		Potable Water System			
			Above-ground inside building	Under-ground under building	Building sewer	Above-ground	Under-ground	Aboveground		Underground	
								Cold	Hot	Under building	Outside building
Brass or bronze threaded water fittings	ASME B16.15	2.2.7.3.	N	N	N	N	N	P	P	P	P
Copper tube											
Types K and L hard temper	ASTM B 88	2.2.7.4.	P	P	P	P	P	P	P	N	N
Types K and L soft temper	ASTM B 88	2.2.7.4.	N	N	N	N	N	P	P	P	P
Type M hard temper	ASTM B 88	2.2.7.4.	P	N	N	P	N	P	P	N	N
Type M soft temper	ASTM B 88	2.2.7.4.	N	N	N	N	N	N	N	N	N
Type DWV	ASTM B 306	2.2.7.4.	P <sup>(11)</sup>	N	N	P <sup>(11)</sup>	N	N	N	N	N
Solder-joint drainage fittings	ASME B16.23	2.2.7.5.	P	P	P	P	P	N	N	N	N
	ASME B16.29										
Solder-joint water fittings	ASME B16.18	2.2.7.6.	N	N	N	P	P	P	P	P	P
	ASME B16.22										
Lead waste pipe	—	2.2.7.8.	P <sup>(4)(5)</sup>	P	N	P <sup>(4)(5)</sup>	P	N	N	N	N

N = Not permitted P = Permitted

**Notes to Table A-2.2.5., 2.2.6. and 2.2.7.:**

- (1) Where fire stops are pierced by pipes, the integrity of the fire stop must be maintained.
- (2) Gasketed joints required.
- (3) Permitted only for water service pipe.
- (4) Combustible piping in noncombustible construction is subject to the requirements of Sentence 3.1.5.19.(1) of Division B of the NBC.
- (5) Combustible piping that penetrates a fire separation is subject to the requirements in Articles 3.1.9.1., 9.10.9.6. and 9.10.9.7. of Division B of the NBC.
- (6) Not permitted in hot water systems.
- (7) Not to exceed design temperature and design pressure stated in Sentence 2.2.5.8.(2).
- (8) Permitted only in buildings of industrial occupancy as described in the NBC, or for the repair of existing galvanized steel piping systems.
- (9) Permitted underground only in a storm drainage system.
- (10) Permitted only for an external leader.
- (11) Not permitted for the fixture drain or vent below the flood level rim of a flush-valve-operated urinal.



**A-2.2.5.2.(3) Concrete Fittings.** Concrete fittings fabricated on the site from lengths of pipe may have proven acceptable on the basis of past performance in some localities and their acceptance under this Code may be warranted.

**A-2.2.5.5.(1) Polyethylene Pipe Used Underground.** Joints within the high-density polyethylene pipe (HDPE) shall be heat-fused according to the manufacturer's instructions. Joints between HDPE pipes and other materials shall be made with a suitable hubless coupling.

**A-2.2.5.6.(1) Crosslinked Polyethylene Pipe and Fittings.** There are some special installation requirements for the use of crosslinked polyethylene pipe and its associated fittings. Reference should, therefore, be made to the installation information in CAN/CSA-B137.5, "Crosslinked Polyethylene (PEX) Tubing Systems for Pressure Applications."

**A-2.2.5.9. to 2.2.5.11. Solvent Cement.** CAN/CSA-B137.6, "Chlorinated Polyvinylchloride (CPVC) Pipe, Tubing, and Fittings for Hot- and Cold-Water Distribution Systems," CAN/CSA-B181.1, "Acrylonitrile-Butadiene-Styrene (ABS) Drain, Waste, and Vent Pipe and Pipe Fittings," and CAN/CSA-B181.2, "Polyvinylchloride (PVC) and Chlorinated Polyvinylchloride (CPVC) Drain, Waste, and Vent Pipe and Pipe Fittings," reference ASTM D 3138, "Solvent Cements for Transition Joints Between Acrylonitrile-Butadiene-Styrene (ABS) and Poly(Vinyl Chloride) (PVC) Non-Pressure Piping Components," which specifies the colour of the solvent cement. PVC cement shall be grey, ABS cement shall be yellow, CPVC cement shall be clear and transition cement shall be white. The standard colour allows Code users to readily determine if the correct solvent cement has been used. It should be noted that a transition cement is not an all-purpose cement.

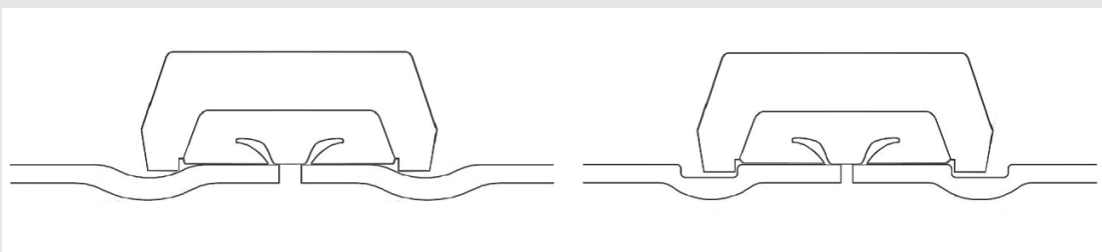
**A-2.2.5.12.(1) Polyethylene/Aluminum/Polyethylene Composite Pipe and Fittings.** There are some special installation requirements for the use of polyethylene/aluminum/polyethylene composite pipe and fittings. Reference should, therefore, be made to the installation information in CAN/CSA-B137.9, "Polyethylene/Aluminum/Polyethylene (PE-AL-PE) Composite Pressure-Pipe Systems."

**A-2.2.5.13.(1) Crosslinked Polyethylene/Aluminum/Crosslinked Polyethylene Composite Pressure Pipe and Fittings.** There are some special installation requirements for the use of crosslinked polyethylene/aluminum/crosslinked polyethylene composite pipe and fittings. Reference should, therefore, be made to the installation information in CAN/CSA-B137.10, "Crosslinked Polyethylene/Aluminum/Crosslinked Polyethylene (PEX-AL-PEX) Composite Pressure-Pipe Systems."

**A-2.2.5.14.(1) Polypropylene Pipe and Fittings.** There are some special installation requirements for the use of polypropylene pipe and fittings. Reference should, therefore, be made to the installation information in CAN/CSA-B137.11, "Polypropylene (PP-R) Pipe and Fittings for Pressure Applications."

**A-2.2.6.8.(3) Galvanized Steel Pipe.** The use of galvanized steel pipe and fittings in a water distribution system may have proven acceptable on the basis of past performance in some localities and its acceptance under this Code may be warranted.

**A-2.2.10.4.(1) Fittings in Pressure Piping Applications.** Piping used in pressure applications are to be grooved and constructed using tools specifically designed for that piping material. It is important that all groove profiles are to meet the fitting manufacturer's guidelines and conform to CSA-B242 "Groove and Shoulder-Type Mechanical Pipe Couplings." Overly shallow roll grooved or cut connections may result in reduced working pressures at the joint or the failure of the connection due to insufficient engagement of the coupling or from slippage at the joint. Conversely, grooves or cuts that are overly deep may result in failures of the pipe stemming from corrosion or stress concentrations at the joints.



Note: Image is exaggerated for clarity

**Figure A-2.2.10.4.(1)**  
**Insufficient Key Engagement of Fitting in Roll Grooved Connection**

**A-2.2.10.5.(1) Saddle Hubs or Fittings.** Saddle hubs or fittings may have proven acceptable on the basis of past performance in some localities and their acceptance under this Code may be warranted.

**A-2.2.10.6.(2) Supply Fittings and Individual Shower Heads.** Flow restriction devices within supply fittings should not be removed.

Due to the low flow rate of public lavatory faucets, design consideration should be given to the wait time for hot water to be delivered to each fixture.

**A-2.2.10.6.(3) Automatic Compensating Valves.** When replacing a shower head, the appropriate shower valve with a suitable compensating feature matching the flow rate should be chosen to decrease the possibility that users will suffer thermal shock. The water flow rate of automatic compensating mixing valves can be found in ASSE 1016/ASME 112.1016/CSA B125.16, “Performance Requirements for Automatic Compensating Valves for Individual Showers and Tub/Shower Combinations.”

**A-2.2.10.6.(4) and (5) Automatic Shut-off of Water Flow.** Examples of water shut-off devices include occupant sensors and self-closing valves.

**A-2.2.10.7. Hot Water Temperature.** Hot water delivered at 60°C will severely burn human skin in 1 to 5 seconds. At 49°C, the time for a full thickness scald burn to occur is 10 minutes. Children, the elderly and persons with disabilities are particularly at risk of scald burns. Compliance with Article 2.2.10.7. will reduce the risk of scalding in showers and bathtubs, and reduce the risk of thermal shock from wall-mounted shower heads. These requirements apply to all occupancies, not just residential occupancies. The water outlet temperature at other fixtures, such as lavatories, sinks, laundry trays or bidets, is not addressed by Article 2.2.10.7., but a scald risk may exist at such fixtures nonetheless.

**A-2.2.10.9.(3) Bubblers.** Bubblers installed on other than drinking fountains may have proven acceptable on the basis of past performance in some localities and their acceptance under this Code may be warranted.

**A-2.2.10.16.(1) Air Admittance Valve.** An air admittance valve is a device that is closed by gravity and seals the vent terminal at zero differential pressure (no flow conditions) and under positive internal pressures. The valve allows air to enter the drainage system without the use of a vent extended to outside air and prevents trap siphonage.

The material of the diaphragm can be damaged by exposure to acidic or corrosive fumes in the ambient atmosphere; therefore, air admittance valves should not be installed in locations where there is a potential for exposure to such fumes.

**A-2.2.10.17. Water Treatment Systems.** The potential risk for substances to be introduced into the drinking water that may endanger health must be considered. All proposals to install water treatment devices shall address:

- Seismic and environmental concerns,
- Monitoring and tampering detection,
- Protection of the city water supply and interface with the existing distribution system,
- Notification of end users and record keeping,
- Chemical storage and security, and
- Spill containment and procedures in the event of an equipment malfunction such as incorrect dosing.

For proposed new installations, the *Chief Building Official* will require:

- A technical report from a *registered professional* with appropriate qualifications and training identifying the context of installation, performance specifications of the proposed equipment, and the technical basis for the installation and means to protect the general public and end users,
- A piping diagram of the proposed water distribution system showing the type of existing piping and equipment, and
- A letter from the owner(s) stating that all end users have been informed of the proposal to introduce such chemicals into the drinking water and a sign has been posted in a conspicuous place 30 days before the proposed date of installation detailing the scope of the installation, the name of the chemicals being introduced and the relevant safety data sheets (SDS).

**A-2.2.11.4.(2) Non-recirculating Applications.** Non-recirculating water systems, such as *once-through cooling equipment*, waste large volumes of drinking water. Only in exceptional circumstances will a request for an *operating permit* be considered, such as a life safety application for which a *registered professional* has formally documented that there is no practical alternative to once-through cooling.

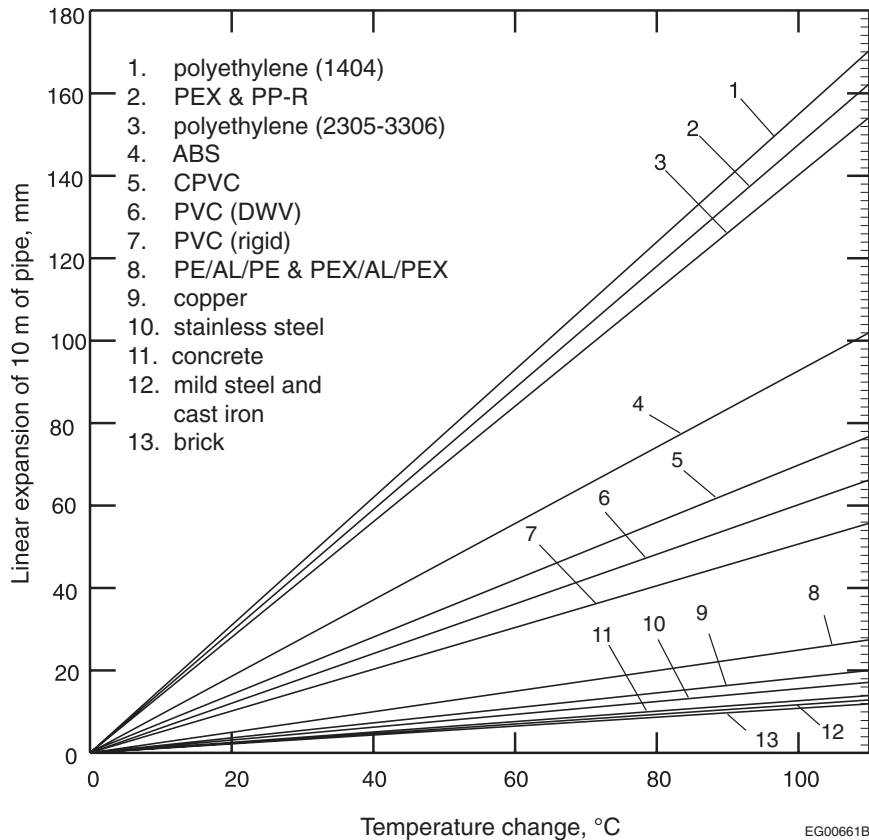
**A-2.2.11.6. Cooling Tower Start-up and Shut-down.** It is not the intention that the undefined terms “start-up” and “shut down” within Clause (4)(a), Clause (7)(c), Clause (9)(b) or Sentence (10) be interpreted to include a brief shutdown for the purposes of physical cleaning, system maintenance or inspection, or a “Standby (wet)” mode of *cooling tower* operation as defined by ASHRAE Guideline 12-2020. Operating a *cooling tower* in a “Standby (wet)” mode should include maintaining the water treatment program and circulating water to control biological growth, as described in ASHRAE Guideline 12-2020.

Rev.  
12997

**A-2.2.11.6.(8) Required Response to Failure to Meet *Legionella* Standards.** This Sentence is based on Public Services and Procurement Canada’s standard MD 15161 – 2013, “Control of *Legionella* in Mechanical Systems.”

**A-2.3.2.6.(1) Mechanical Joints.** Storm sewer blockage can cause mechanical joints at the base of leaders to fail, which results in flooding. The failure occurs because the cleanout joints at the base of the rainwater leaders are not able to withstand the water column pressure. To avoid such failures, it is necessary to ensure that storm water systems installed using mechanical joints be braced and/or restrained at the ends of branches, changes in direction and elevation, at dead ends and at other locations as required by the manufacturer to prevent the separation of joints due to internal pressure, mechanical stress or seismic events. Care should be taken to replace cleanouts properly after maintenance or testing.

**A-2.3.3.9. Linear Expansion.**



**Figure A-2.3.3.9. Linear Expansion**

Example: To determine the expansion of 20 m of ABS pipe for a temperature change from 10°C to 60°C.

Temperature change = 60 – 10 = 50°C,

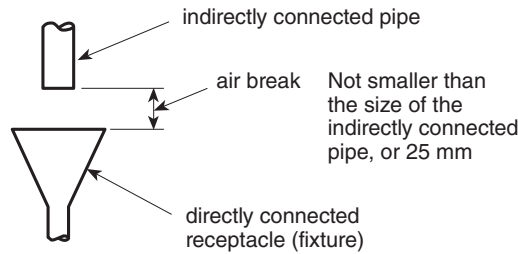
Enter the chart at 50°C, read up to ABS line, and then across to the mm scale = 47 mm/10 m of pipe,

∴ change in length of 20 m of pipe =

$$\frac{20}{10} \times 47 = 94mm$$

**A-2.3.3.9.(1) Expansion and Contraction.** Expansion and contraction in piping systems may be accommodated in a number of ways including, but not limited to, piping design and layout, material selection, and the inclusion of expansion joints.

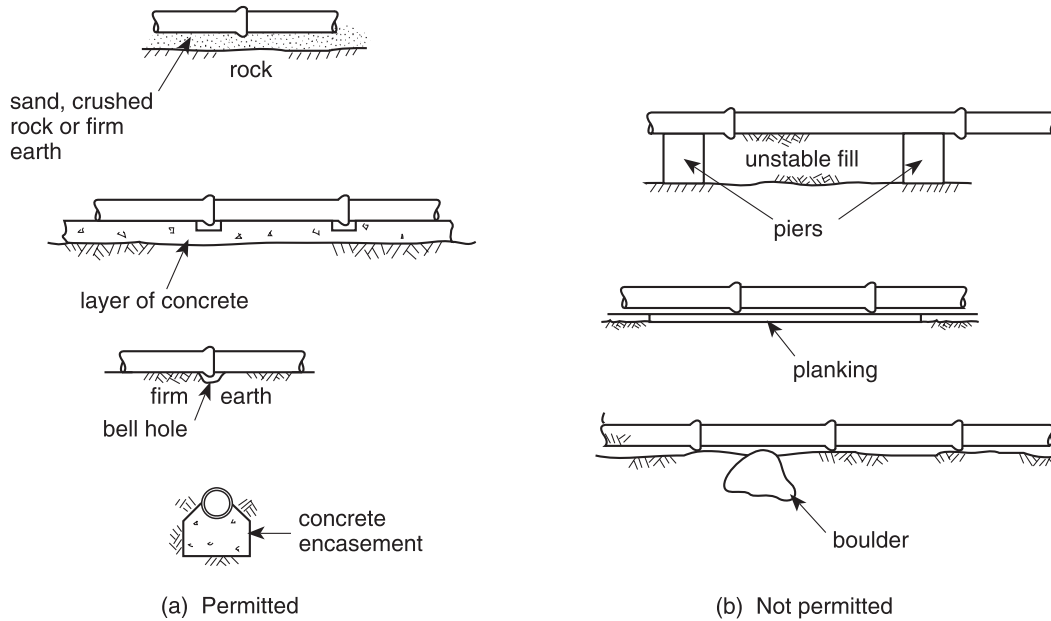
**A-2.3.3.11.(2) Air Break.**



EC01136A

**Figure A-2.3.3.11.(2)**  
**Air Break**

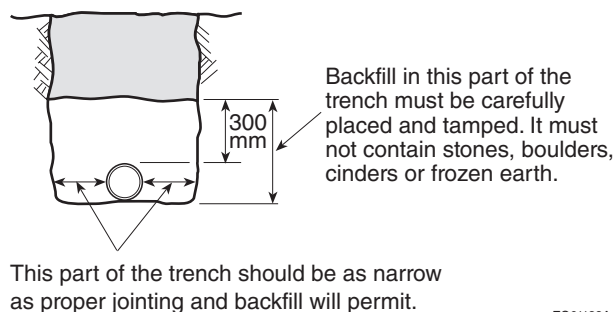
**A-2.3.4.6.(1) Support for Underground Piping.** See explanation for Subsection 2.3.5. for additional protection required for underground pipes. Permitted installations are shown in Figure A-2.3.4.6.(1)(a). The methods of support shown in Figure A-2.3.4.6.(1)(b) are not permitted because the base does not provide firm and continuous support for the pipe.



EG01137B

**Figure A-2.3.4.6.(1)**  
**Support for Underground Piping**

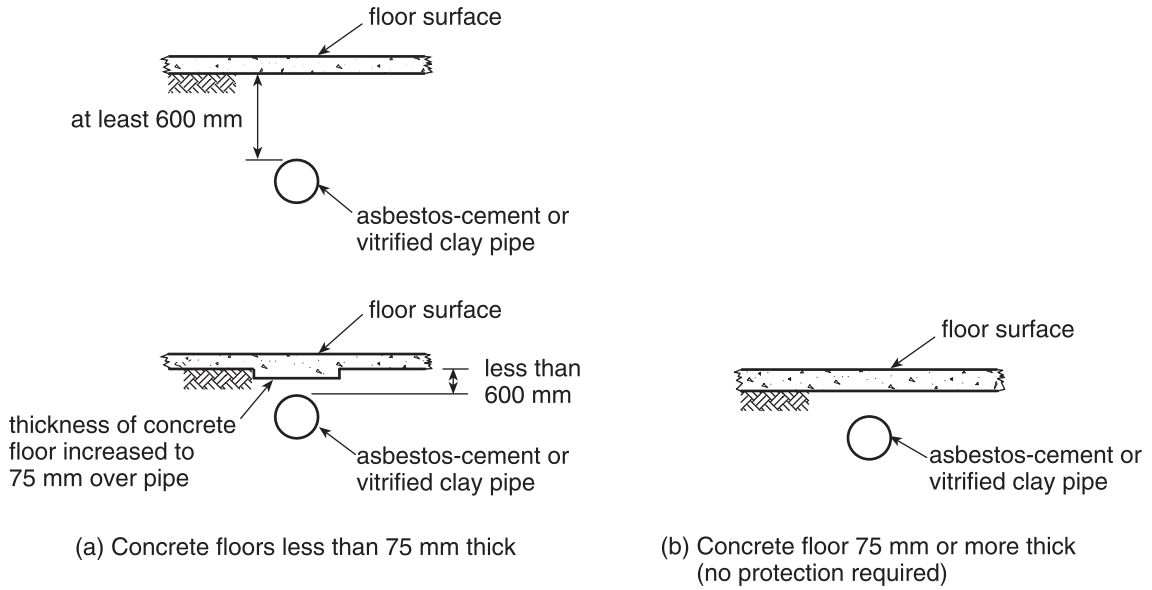
**A-2.3.5.1.(1) Backfilling of Pipe Trench.** Stronger pipes may be required in deep fill or under driveways, parking lots, etc., and compaction for the full depth of the trench may be necessary.



EG01138A

**Figure A-2.3.5.1.(1)**  
**Backfilling of Pipe Trench**

**A-2.3.5.2.(1) Protection of Underground Non-Metallic Pipes.**



EG01139B

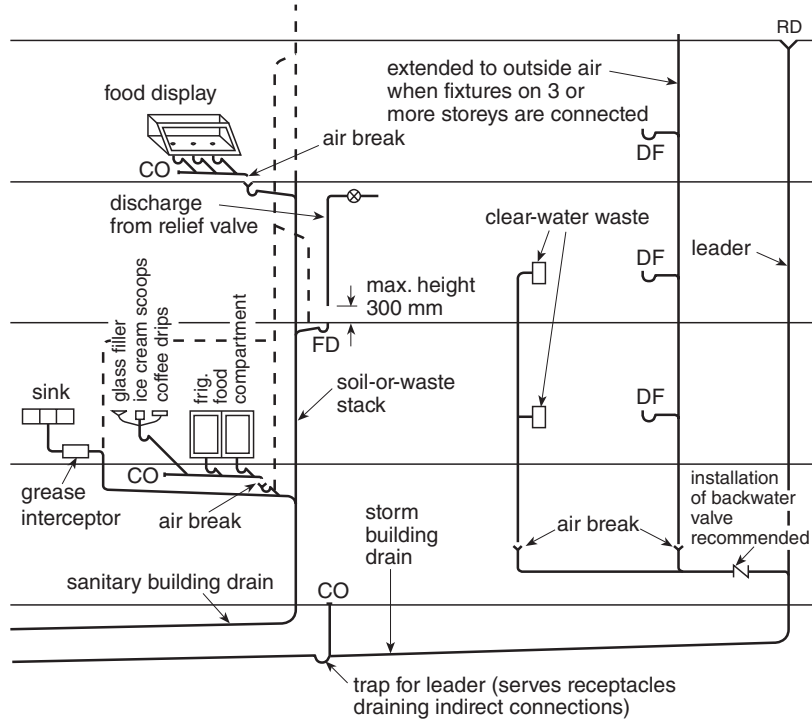
**Figure A-2.3.5.2.(1)**  
**Protection of Underground Non-Metallic Pipes**

**A-2.3.5.4. Protection of Piping Against Freezing.** The TIAC “Mechanical Insulation Best Practices Guide” is a comprehensive source of information on the selection, installation and proper use of thermal insulation materials. (Note that Section 4 of this Guide is not included in the scope of this Note as it contains information on proprietary products, which are not within the mandate of the Code.)

**A-2.3.7.2.(2) Pressure-Testing of Potable Water Systems.** The plastic piping manufacturer should be consulted to determine the appropriateness of using air to pressure-test the piping system.

**A-2.4.2.1.(1)(a)(ii) and (e)(vi) Indirect Connections.** See Sentence 2.4.5.1.(4) for trapping requirements for indirectly connected fixtures.

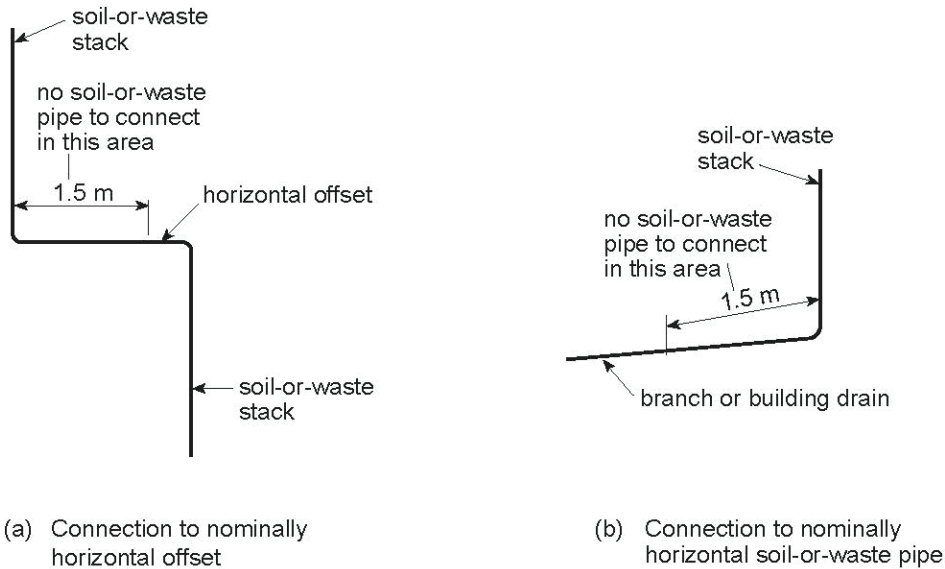
See Sentence 2.4.7.1.(9) for cleanouts on drip pipes for food receptacles or display cases.



EG01140B

Figure A-2.4.2.1.(1)(a)(ii) and (e)(vi)  
Indirect Connections

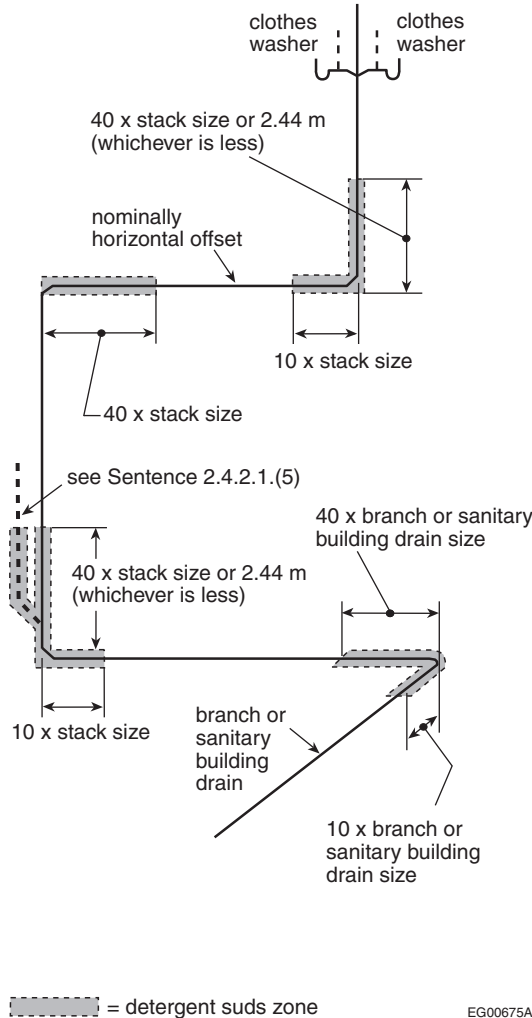
**A-2.4.2.1.(2) Soil-or-Waste Pipe Connections.**



EG01141A

Figure A-2.4.2.1.(2)  
Soil-or-Waste Pipe Connections

**A-2.4.2.1.(4) Suds Pressure Zones.** High sudsing detergents used in clothes washers produce suds that tend to disrupt the venting action of venting systems and can also spread through the lower portions of multi-storey drainage systems. The more turbulence, the greater the suds. One solution that avoids the creation of suds pressure zones involves connecting the suds-producing stack downstream of all other stacks and increasing the size of the horizontal building drain to achieve a greater flow of air and water. Using streamlined fittings, such as wyes, tends to reduce suds formation. Check valves or backwater valves in fixture outlet pipes have also been used to correct problem installations.



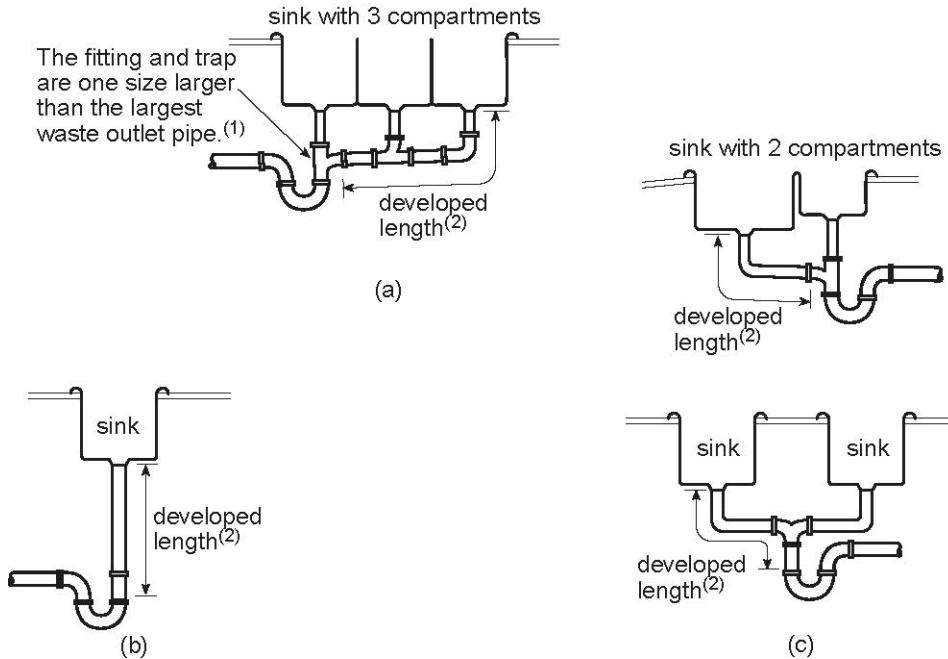
**Figure A-2.4.2.1.(4)**  
**Suds Pressure Zones**

**A-2.4.3.3.(1) Waste with Organic Solids.** Equipment such as garbage grinders and potato peelers produces waste with organic solids. These devices reduce most waste into small-sized particles that will flow easily through the drainage system. However, if they are located upstream of the interceptor, the particles could block the interceptor.

**A-2.4.4.3.(1) Grease Interceptors.** Grease interceptors may be required when it is considered that the discharge of fats, oil or grease may impair the drainage system. Information on the design and sizing of grease interceptors can be found in ASPE 2012, “Plumbing Engineering Design Handbook, Volume 4, Chapter 8, Grease Interceptors.”

**A-2.4.4.4.(1) Bio-hazardous Waste.** Chemically loaded and bio-hazardous wastes can be dangerous to private or public sewer systems and hazardous to people. The treatment of corrosive and acid waste is mandated by this Code. The treatment of chemically loaded effluents is usually regulated by sewage collecting and treatment authorities. The treatment of bio-hazardous waste should follow “good engineering practice,” such as that described in Laboratory Biosafety Guidelines published by Health Canada. It should be noted that bio-hazardous waste disposal systems require specific engineering expertise and remain outside the scope of this Code.

**A-2.4.5.1.(2) Trapping of Sinks and Laundry Trays.**



EG01142B

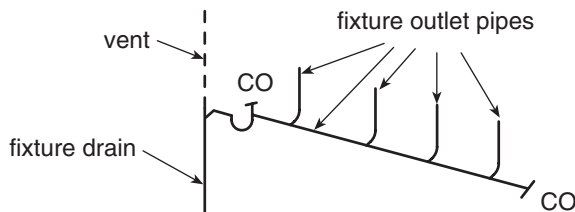
**Figure A-2.4.5.1.(2)**  
**Trapping of Sinks and Laundry Trays**

**Notes to Figure A-2.4.5.1.(2):**

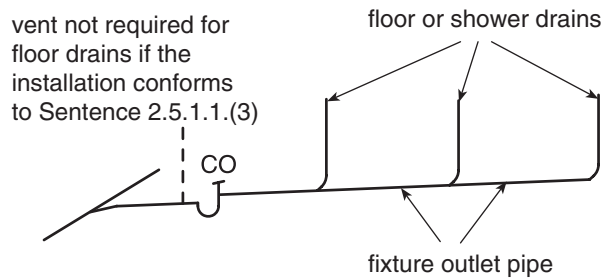
(1) See Sentence 2.4.9.3.(2).

(2) The developed length of the fixture outlet pipe shall not exceed 1 200 mm. See Article 2.4.8.2.

**A-2.4.5.1.(3) Single Traps for Fixture Groups.**



(a) Laboratory sinks or washing machines



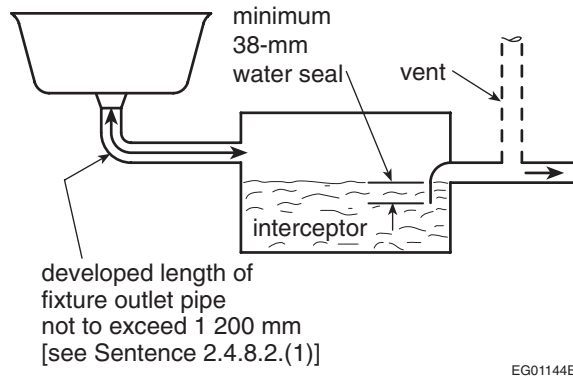
(b) Floor drains and shower drains

EG01149A

**Figure A-2.4.5.1.(3)**  
**Single Traps for Fixture Groups**



**A-2.4.5.1.(5) Location of Trap or Interceptor.** An interceptor that replaces a trap must be vented in the same way as the trap it replaces. (See Note A-2.4.2.1.(1)(a)(ii) and (e)(vi).) Where an interceptor other than an oil interceptor serves a group of fixtures requiring more than one trap, each fixture must be properly trapped and vented. (See Article 2.5.5.2. for venting of oil interceptors.)

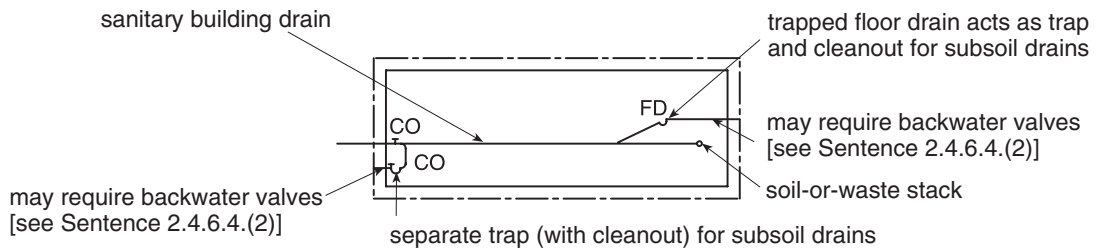


EG01144B

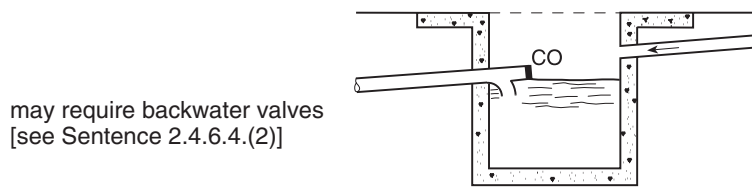
**Figure A-2.4.5.1.(5)**  
Location of Trap or Interceptor

**A-2.4.5.2.(1) Untrapped Leader.** When an untrapped leader drains to a combined building sewer, clearance requirements are the same as for vent terminals. (See also Note A-2.5.6.5.(4).)

**A-2.4.5.3.(1) Subsoil Drainage Connections.** This Code does not regulate the installation of subsoil drainage pipes, but does regulate the connection of such pipes to the plumbing system. The intent of this Article is to place a trap between the subsoil drainage pipe and the sanitary drainage system. The cleanout must be installed in accordance with Sentence 2.4.7.1.(2). A trap or sump may be provided specifically for the subsoil drains, or advantage may be taken of the trap of a floor drain or storm water sump as shown in Figure A-2.4.5.3.(1).



(a) Connections to sanitary drainage system (plan view)

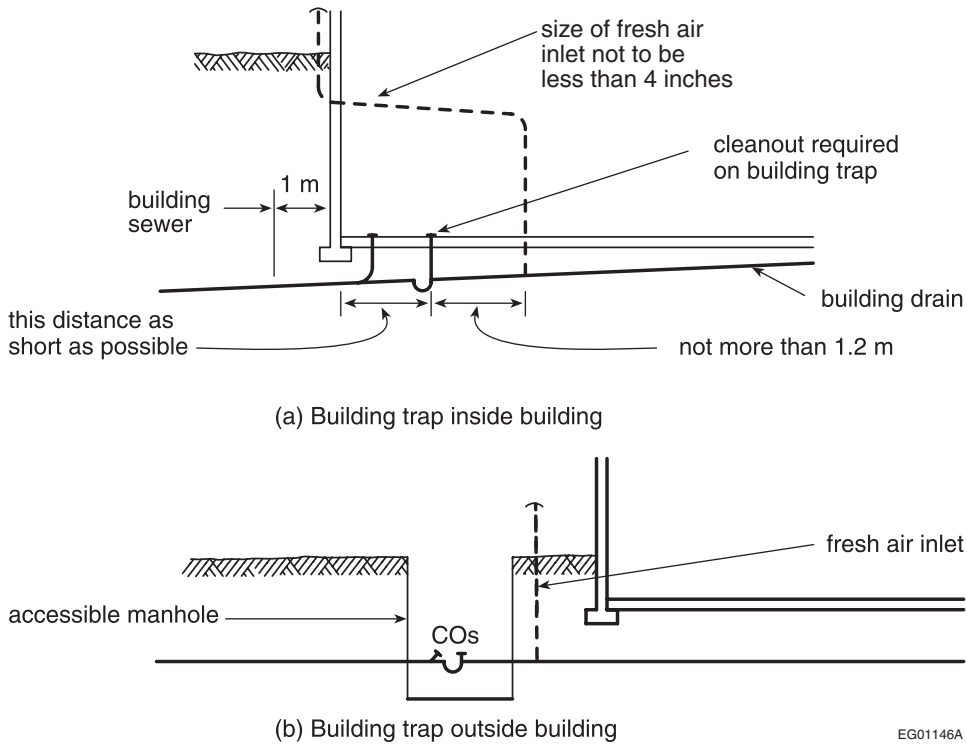


(b) Trapped sump

EG01145B

**Figure A-2.4.5.3.(1)**  
Subsoil Drainage Connections

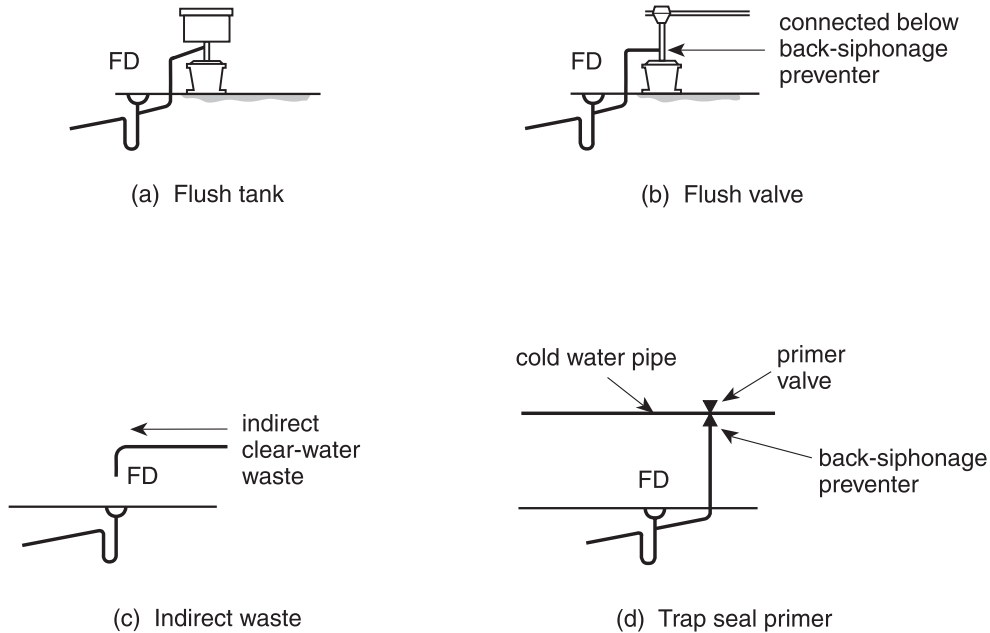
**A-2.4.5.4.(1) Location of Building Traps.**



EG01146A

**Figure A-2.4.5.4.(1)**  
**Location of Building Traps**

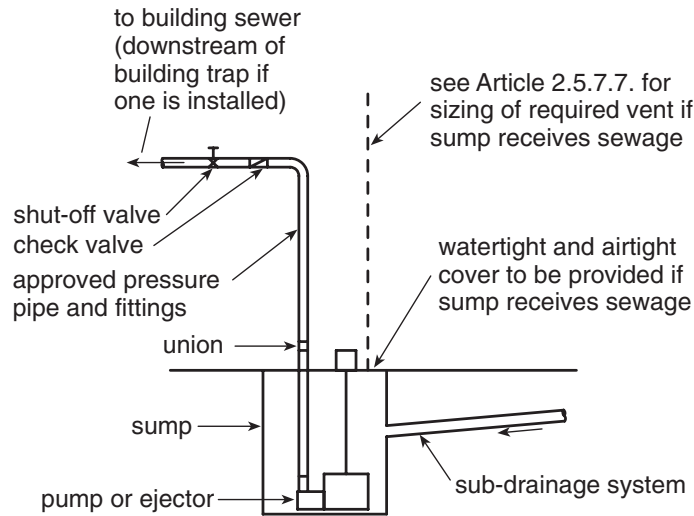
**A-2.4.5.5.(1) Maintaining Trap Seals.** Periodic manual replenishment of the water in a trap is considered to be an equally effective means of maintaining the trap seal in floor drains in residences. Under pressure differential conditions, special measures are necessary to maintain trap seals.



EG01147A

**Figure A-2.4.5.5.(1)**  
**Maintaining Trap Seals**

**A-2.4.6.3 Arrangement of Piping at Sump.** In most installations, controls will be installed in conjunction with a float to automatically empty the sump. If such controls are not provided, the capacity of the sump should equal the maximum inflow to the sump that is expected to occur during any 24 h period.



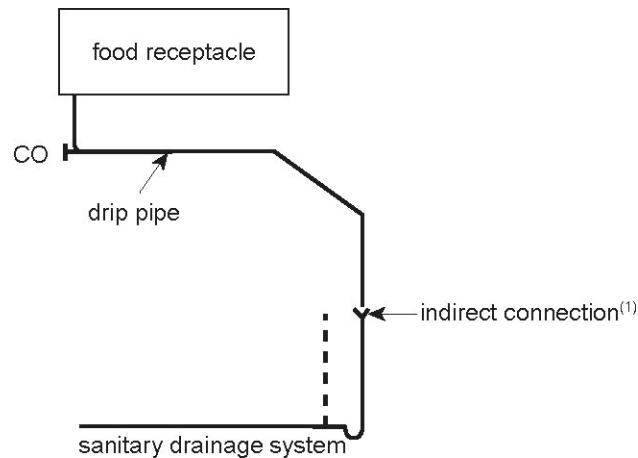
**Figure A-2.4.6.3.**  
Arrangement of Piping at Sump

**A-2.4.6.4.(1) Deleted.**

Rev.  
12717

**A-2.4.7.1.(6) Cleanouts for Drainage Systems.** To accommodate the limitations of sewer cleaning equipment, the cleanout should be located as close as possible to the exterior wall of the building, either inside or outside, and be accessible for sewer cleaning equipment.

**A-2.4.7.1.(9) Cleanouts for Food Receptacle Drip Pipes.**



EG01150B

**Figure A-2.4.7.1.(9)**  
Cleanouts for Food Receptacle Drip Pipes

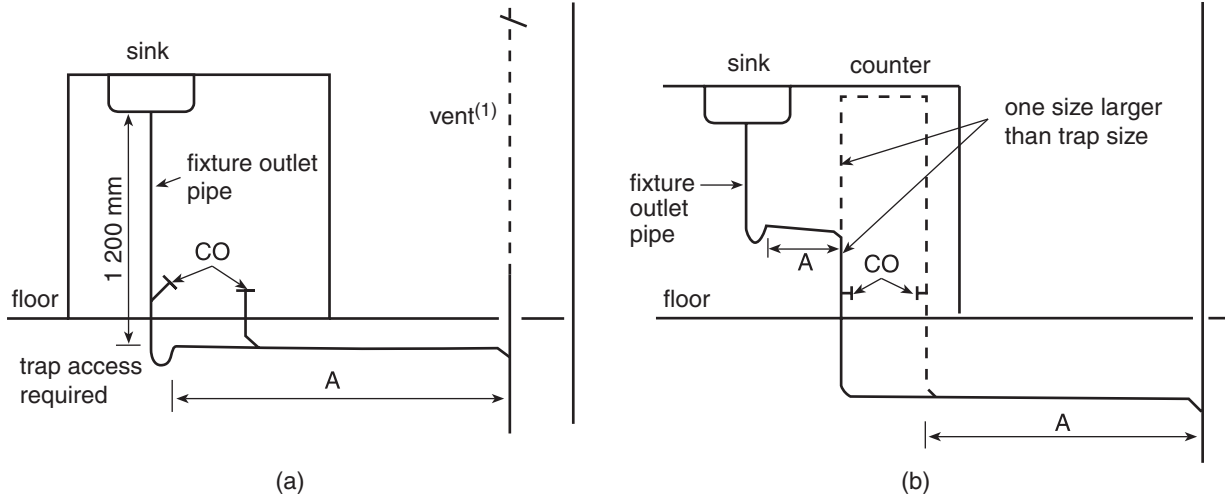
**Note to Figure A-2.4.7.1.(9):**

(1) See Article 2.4.2.1.

**A-2.4.7.1.(10) Cleanouts for Fixture Drains.** A trap cleanout plug cannot be used as a cleanout for a fixture drain.

**A-2.4.8.1.(1) Minimum Slope.** Although slopes below 1 in 100 are permitted for pipes over 4 inches, they should be used only where necessary. Steeper slopes and higher velocities will help to keep pipes clean by moving heavier solids that might tend to clog the pipes.

**A-2.4.8.2.(1) Island Fixture Installation.**



Fixture trap size, in.	Length of A, <sup>(2)</sup> m
1½	1.8
2	2.4
3	3.6

EG02009A

**Figure A-2.4.8.2.(1) Island Fixture Installation<sup>(3)</sup>**

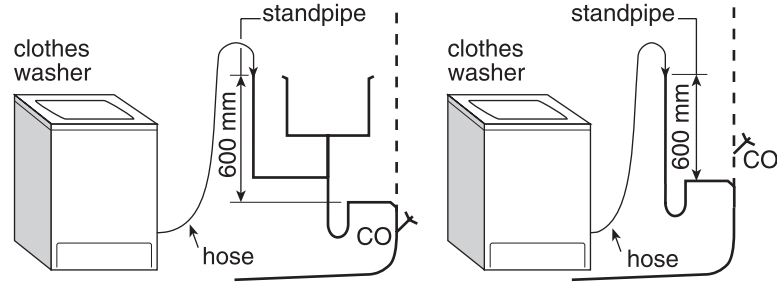
**Notes to Figure A-2.4.8.2.(1):**

- (1) Vent size to be in accordance with Article 2.5.6.3.
- (2) Length of A depends on trap size. Fall cannot exceed size.
- (3) See also Article 2.5.1.1.

**A-Table 2.4.9.3 Hydraulic Loads for Laundry Traps and Floor Drains.** When determining the hydraulic load on a pipe, no allowance need be made for a load from a domestic clothes washer when discharged to a laundry tray since the hydraulic load from the laundry tray is sufficient. Also no hydraulic load is required from a floor drain in a washroom since it is for emergency use only.

**A-2.4.9.3.(2) Continuous Wastes.** Fixture outlet pipes that are common to 2 or 3 compartments or fixtures are sometimes referred to as continuous wastes and are not considered to be branches. (See also Note A-2.4.5.1.(2).)

**A-2.4.9.3.(3) Standpipe Illustration.**



The standpipe must extend above the flood level rim of the washer and measure a minimum of 600 mm.

EG02005A

**Figure A-2.4.9.3.(3) Standpipe Installation for Clothes Washers**

**A-2.4.10. Determination of Hydraulic Loads and Drainage Pipe Sizes.**

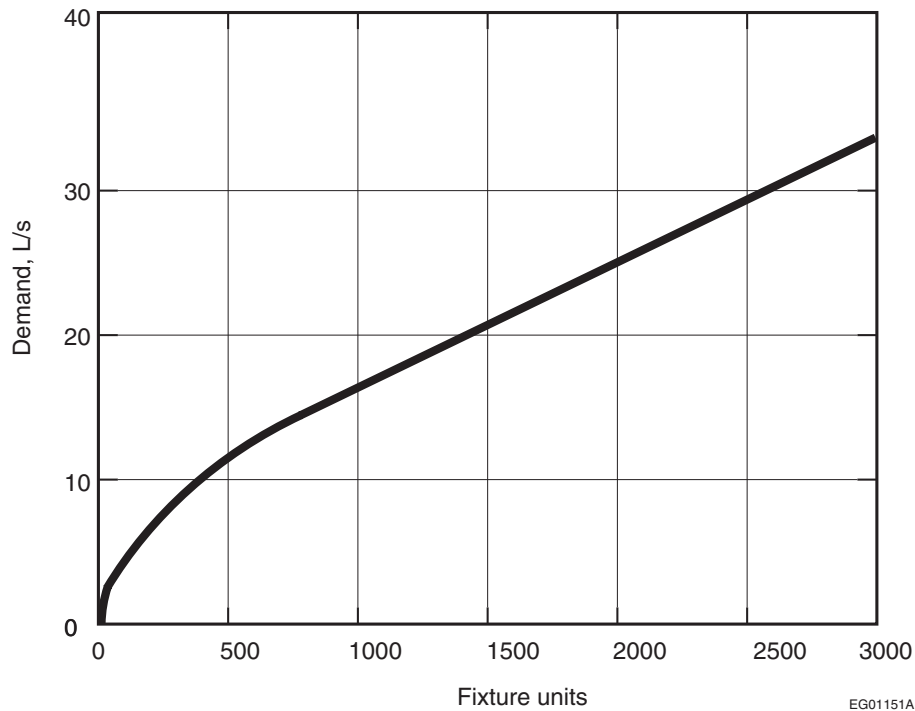
**Hydraulic Loads**

The hydraulic load that is imposed by a fixture is represented by a factor called a fixture unit. Fixture units are dimensionless and take into account the rate of discharge, time of discharge and frequency of discharge of the fixture.

Confusion often arises when attempts are made to convert fixture units to litres per second because there is no straightforward relationship between the two. The proportion of the total number of fixtures that can be expected to discharge simultaneously in a large system is smaller than in a small system. For example, doubling the number of fixtures in a system will not double the peak flow that the system must carry, although of course the flow will be increased somewhat. Figure A-2.4.10.-A shows the relationship that was used in constructing the tables of capacities of stacks, branches, sanitary building drains and sanitary building sewers (Tables 2.4.10.6.-A to 2.4.10.6.-C).

Although the curve in Figure A-2.4.10.-A was used to prepare the Code tables, it was not included in the National Plumbing Code. Instead, a single approximate conversion factor is given in the Code so that a continuous flow from a fixture may be converted from litres per second to fixture units in order to determine the total hydraulic load on the sanitary drainage system. The conversion factor, which is given in Sentence 2.4.10.3.(1), is 31.7 fixture units per litres per second. The discharge from a continuous flow fixture in litres per second when multiplied by 31.7 gives the hydraulic load in fixture units, and that load is added to the fixture unit load from other fixtures to give the total load that the sanitary drainage pipe must carry.

The hydraulic load that is produced by storm water runoff depends both on the size of the area that is drained and local rainfall intensity. The capacities of storm drainage pipes and combined sewers in Tables 2.4.10.9., 2.4.10.10. and 2.4.10.11. have been expressed in terms of the number of litres that they can carry when the local rainfall intensity is 1 mm in 15 min. The hydraulic load for a particular location is obtained by simply multiplying the rainfall intensity figure given in Appendix C of Division B of the NBC by the actual area drained as specified in Sentence 2.4.10.4.(1).



**Figure A-2.4.10.-A Relationship between Fixture Units and Demand**

In the case of restricted-flow drains, the hydraulic load from storm water runoff must be calculated using manufacturer discharge flow rates of specific drains in the case of roofs, and water-flow restrictors in the case of paved areas.

When plumbing fixtures are connected to a combined sewer, the hydraulic load from the fixtures must be converted from fixture units to litres or, in the case of continuous flow, from litres per second to litres so that these loads can be added to the hydraulic loads from roofs and paved surfaces. As already pointed out, the relationship between fixture units and litres per second and, consequently, the relationship between fixture units and litres is not straightforward, and an approximate conversion factor has been adopted. The conversion factor given in Sentence 2.4.10.5.(1) is 9.1 L/fixture unit, except where the load is less than 260 fixture units in which case a round figure of 2 360 L is to be used. In the case of continuous-flow fixtures that are connected

to combined sewers or storm sewers, the conversion factor given in Sentence 2.4.10.3.(2) is 900 L per L/s. This conversion factor is not an approximation but an exact calculation.

The conversion factors given in Sentences 2.4.10.3.(1) and 2.4.10.5.(1) are designed to convert in one direction only, and must not be used to convert from fixture units to litres per second in the one instance, nor from litres to fixture units in the other instance.

In summary, it should be noted that

- (a) in sanitary drainage systems, all hydraulic loads are converted to fixture units, and
- (b) in storm drainage systems or combined drainage systems, all hydraulic loads are converted to litres.

### Procedure for Selecting Pipe Sizes

The following is an outline, with examples, of the procedures to be followed in determining the size of each section of drainage piping.

(1) Sanitary drainage pipes, such as branches, stacks, building drains or building sewers:

- (a) Determine the load in fixture units from all fixtures except continuous-flow fixtures;
- (b) Determine the load in litres per second from all continuous-flow fixtures and multiply the number of litres per second by 31.7 to obtain the number of fixture units;
- (c) Add loads (a) and (b) to obtain the total hydraulic load on the pipe in fixture units; and
- (d) Consult the appropriate table from Table 2.4.10.6.-A, 2.4.10.6.-B or 2.4.10.6.-C to select the pipe size.

(Note that no pipe size may be smaller than that permitted in Subsection 2.4.9.)

(2) Storm drainage pipes, such as gutters, leaders, horizontal pipes, building drains or building sewers:

- (a) Determine the area in square metres of roofs and paved surfaces according to Sentence 2.4.10.4.(1);
- (b) Determine the local rainfall intensity (15 min rainfall) from Appendix C of Division B of the NBC;
- (c) Multiply (a) by (b) to obtain the hydraulic load in litres;
- (d) If a fixture discharges a continuous flow to the storm system, multiply its load in litres per second by 900 to obtain the hydraulic load in litres;
- (e) If flow control roof drains are used, compute the discharge rate based on rain intensity, retention duration, accumulation height and roof area from the roof drain manufacturers' data;
- (f) Add loads (c) or (e), and (d) to obtain the total hydraulic load on the pipe in litres; and
- (g) Consult the appropriate table from Table 2.4.10.9., 2.4.10.10. or 2.4.10.11. to select the pipe or gutter size.

(Note that no pipe may be smaller than that permitted in Subsection 2.4.9.)

(3) Combined drainage pipes, such as building sewers:

- (a) Determine the total load in fixture units from all fixtures except continuous-flow fixtures;
- (b) If the fixture unit load exceeds 260, multiply it by 9.1 to determine the equivalent hydraulic load in litres. If the fixture unit load is 260 or fewer fixture units, the hydraulic load is 2 360 L;
- (c) Obtain the hydraulic load from roofs and paved surfaces in the same manner as for storm drains (See 2(a), (b), (c) and (e));
- (d) Obtain the hydraulic load in litres from any continuous-flow source that is connected to the sanitary or storm drainage system in the same manner as for storm drainage pipes (See 2(d));
- (e) Add hydraulic loads (b), (c) and (d) to obtain the total hydraulic load on the pipe in litres; and
- (f) Consult Table 2.4.10.9. to select the pipe size.

(Note that no pipe may be smaller than that permitted in Subsection 2.4.9.)

**Examples**

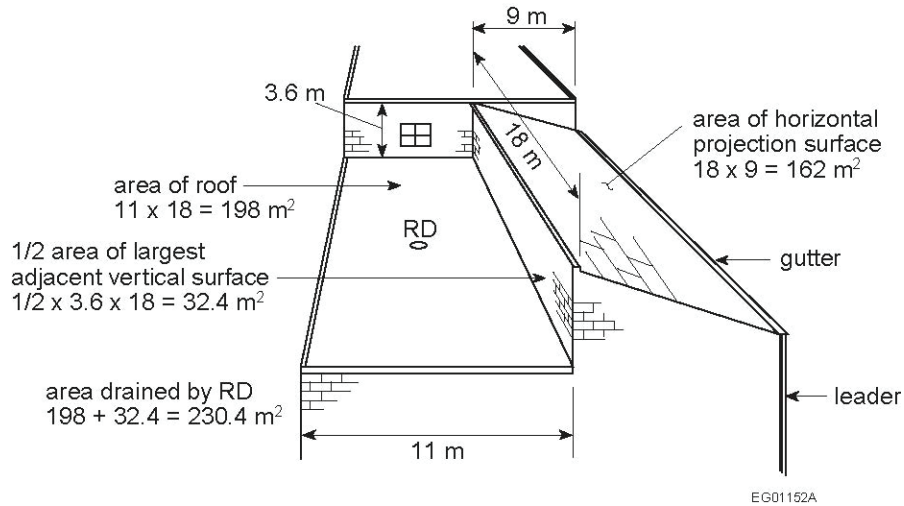
**Example 1: Determination of the size of storm drainage components for the building shown in Figures A-2.4.10.-B and A-2.4.10.-C**

Step No. 1: Determine the hydraulic load from the roofs.

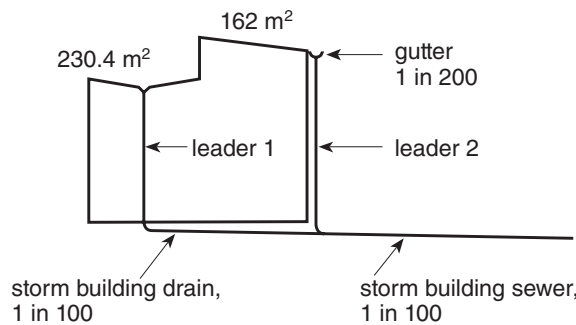
Area drained by gutter	=	162 m <sup>2</sup>
Area drained by roof drain	=	230.4 m <sup>2</sup>
If the local rainfall intensity is 25 mm:		
the load on the gutter (leader No. 2) is (25 × 162)	=	4 050 L
the load on the roof drain (leader No. 1) is (25 × 230.4)	=	5 760 L
If the local rainfall intensity is 15 mm:		
the load on the gutter (leader No. 2) is (15 × 162)	=	2 430 L
the load on the roof drain (leader No. 1) is (15 × 230.4)	=	3 456 L

Step No. 2: Determine the size of storm drainage components.

Using the appropriate hydraulic loads, the size of storm drainage components can be determined from Tables 2.4.10.9., 2.4.10.10. and 2.4.10.11. These values are tabulated in Table A-2.4.10. for rainfall intensities of 25 mm and 15 mm in 15 min.



**Figure A-2.4.10.-B**  
Storm Drainage Areas (Example 1)



**Figure A-2.4.10.-C**  
Storm Drainage Components (Example 1) (Elevation View)

**Table A-2.4.10.**  
**Storm Drainage Pipe Sizes (Example 1)**  
 Forming Part of Note A-2.4.10.

	Area Drained, m <sup>2</sup>	15-min Rainfall Intensity, mm				NPC Reference Table No.
		25		15		
		Hydraulic Load, L	Size, inches	Hydraulic Load, L	Size, inches	
Roof drain leader	230.4	5 760	4	3 456	3	2.4.10.11.
Gutter	162	4 050	8	2 430	7	2.4.10.10.
Gutter leader	162	4 050	3	2 430	2½	2.4.10.11.
Storm building drain	230.4	5 760	5	3 456	4	2.4.10.9.
Storm building sewer	395.8	9 895	6	5 936	5	2.4.10.9.

### Example 2: Determination of the size of drainage pipes for buildings

Figure A-2.4.10.-D represents an office building with washrooms for men and women, a drinking fountain and cleaner's closet on each typical floor. The equipment room with facilities is located in the basement. The building is 18 m by 30 m and is to be built in Kitchener, Ontario.

#### A. Hydraulic Load per Typical Floor

5 WC @ 6	=	30 fixture units
2 UR @ 1½	=	3 fixture units
4 LAV @ 1½	=	6 fixture units
2 FD @ 3	=	6 fixture units
1 FS @ 3	=	3 fixture units
1 DF @ 1	=	1 fixture unit
		<u>49 fixture units</u>

The reader is left to calculate the size of the branches, one of which must be 4 inches and another 3 inches (See Subsection 2.4.9.). Therefore the smallest part of the stack must be 4 inches.

#### B. Hydraulic Load on Stack

5 storeys @ 49 fixture units = 245 fixture units

Table 2.4.10.6.-A permits 4-inch pipe. Use 4-inch pipe.

#### C. Hydraulic Load on Basement Branch

1 WC @ 6	=	6 fixture units
1 LAV @ 1	=	1 fixture unit
2 FD @ 3	=	6 fixture units
1 FS @ 3	=	3 fixture units
Semi-continuous Flow		
0.23 L/s × 31.7	=	7 fixture units
		<u>23 fixture units</u>

Table 2.4.10.6.-B permits 3-inch pipe. Use 3-inch pipe.

#### D. Hydraulic Load on Building Drain

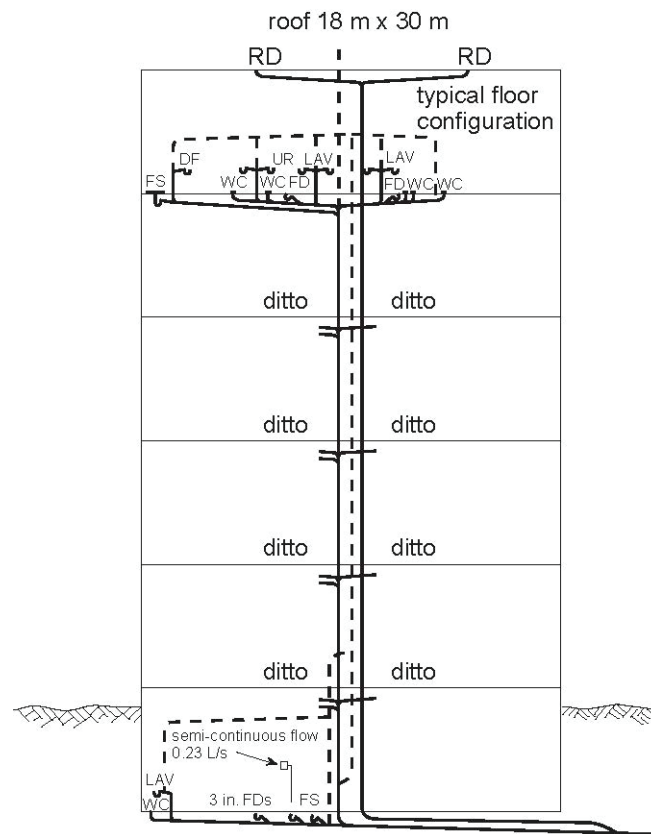
From soil-or-waste stack	245 fixture units
From basement branch	<u>23 fixture units</u>
	<b>268 fixture units</b>

Referring to Table 2.4.10.6.-C, at a slope of 1 in 50, a 4-inch pipe will carry 240 fixture units.

Referring to Table 2.4.10.6.-C, at a slope of 1 in 25, a 4-inch pipe will carry 300 fixture units.

For practical reasons, use a 4-inch pipe at a slope of not less than 1 in 32.





EG01154A

**Figure A-2.4.10.-D**  
**Building Drainage System (Example 2)**

**E. Storm Load**

Area of roof  $18 \times 30 = 540 \text{ m}^2$

Rainfall intensity for Kitchener, taken from Appendix C of Division B of the NBC, is 28 mm in 15 min

Total hydraulic storm load =  $28 \times 540 = 15\,120 \text{ L}$

Storm load on each roof drain =  $15\,120/2 = 7\,560 \text{ L}$

**F. Size of Horizontal Leaders**

Referring to Table 2.4.10.9., at a slope of 1 in 25, a 4-inch pipe will carry a load of 8 430 L.

Referring to Table 2.4.10.9., at a slope of 1 in 100, a 5-inch pipe will carry a load of 7 650 L.

Referring to Table 2.4.10.9., at a slope of 1 in 133, a 6-inch pipe will carry a load of 10 700 L.

Therefore, use a 5-inch pipe at a slope of 1 in 100.

**G. Size of Vertical Leader**

Table 2.4.10.11. would permit a 5-inch pipe (19 500 L) but this size is not readily available. For practical reasons, use a 6-inch pipe.

**H. Size of Storm Building Drains**

Since a drainage pipe cannot be any smaller than any upstream pipes, the storm building drain must be at least 6 inches. Referring again to Table 2.4.10.9., a 6-inch pipe will carry a hydraulic load of 17 600 L at a slope of 1 in 50. Therefore use a 6-inch pipe at a slightly higher slope.

### I. Size of Combined Building Sewer

- (a) Total sanitary load excluding semi-continuous flow 260 fixture units converted to litres  
(Clause 2.4.10.5.(1)(b))  $\times 9.1 = 2\,366\text{ L}$
- (b) Semi-continuous flow 0.23 L/s converted to litres  
(Sentence 2.4.10.3.(2))  $\times 900 = 207\text{ L}$
- (c) Storm load 15 120 L

Total hydraulic load 17 693 L

Referring to Table 2.4.10.9., at a slope of 1 in 50, a 6-inch pipe will carry 17 600 L.

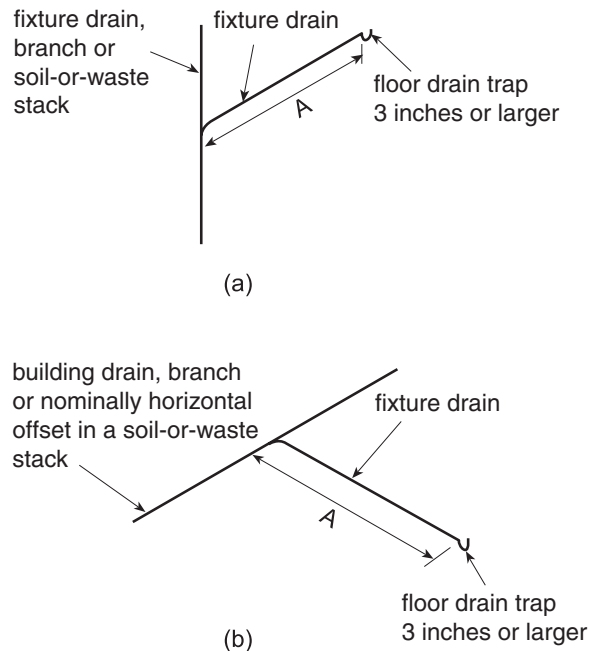
Referring to Table 2.4.10.9., at a slope of 1 in 25, a 6-inch pipe will carry 24 900 L.

Therefore, use a 6-inch pipe at a slope of not less than 1 in 32.

**A-2.4.10.4.(1) Rainfall Intensities.** Climate information on rainfall intensities for various cities can be found in Appendix C of Division B of the NBC.

When calculating the hydraulic load from a roof or paved surface, it should be noted that a 1 mm depth of water on 1 m<sup>2</sup> of surface is equivalent to 1 L.

### A-2.5.1.1.(3) Trapping of Floor Drains.



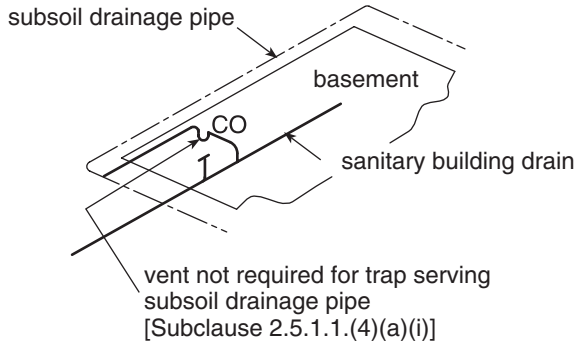
Length of "A" must be at least 450 mm and its fall shall not exceed the size of the pipe.

See also the explanation given in Sentence 2.5.6.3.(1) regarding the fall on fixture drains.

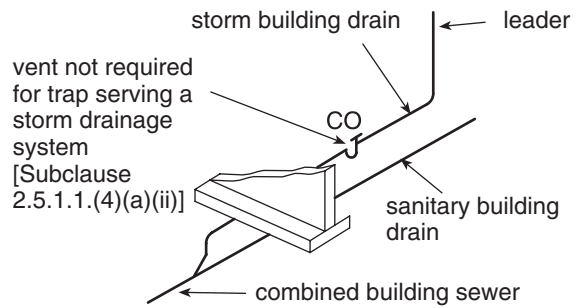
EG01155B

**Figure A-2.5.1.1.(3)**  
Trapping of Floor Drains

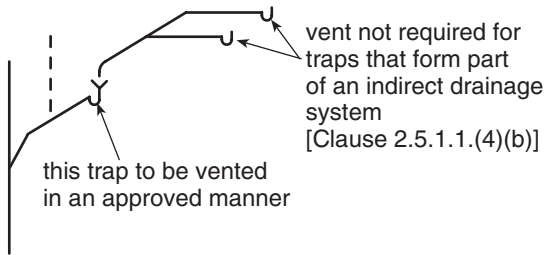
**A-2.5.1.1.(4) Venting not Required.**



(a)



(b)



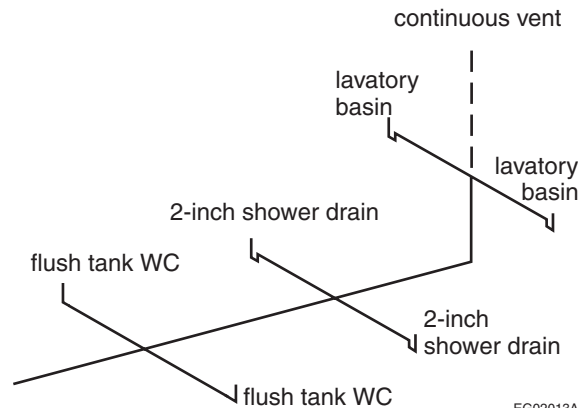
(c)

EG01156B

**Figure A-2.5.1.1.(4) Venting not Required**

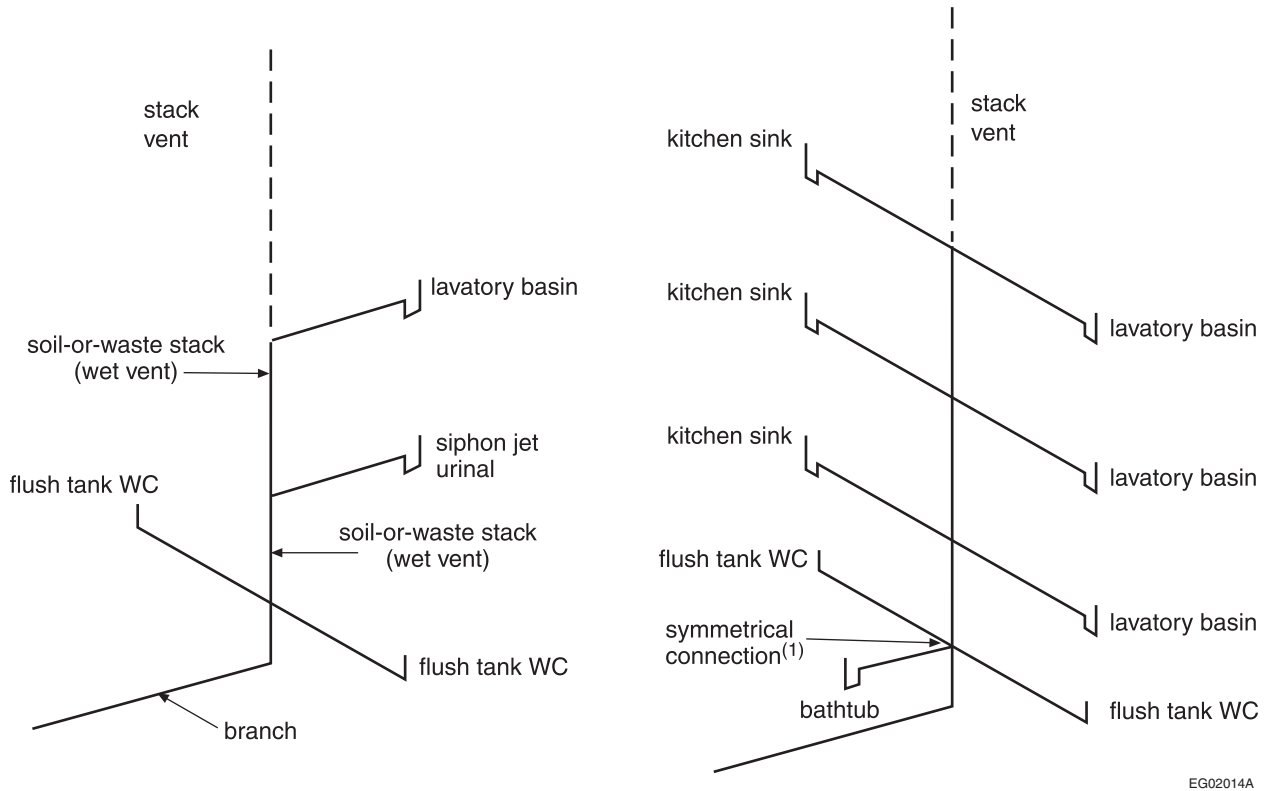
**A-2.5.2.1 Wet Venting.** Single-storey and multi-storey wet venting has been replaced with wet venting (Article 2.5.2.1.) and circuit venting (Article 2.5.3.1.).

The information and figures presented in this Note are examples of the most common installation practices that meet NPC requirements. However, the examples shown do not preclude other installations that would also conform to NPC requirements.



EG02013A

**Figure A-2.5.2.1.-A Example of Wet Venting Described in Clause 2.5.2.1.(1)(b)**

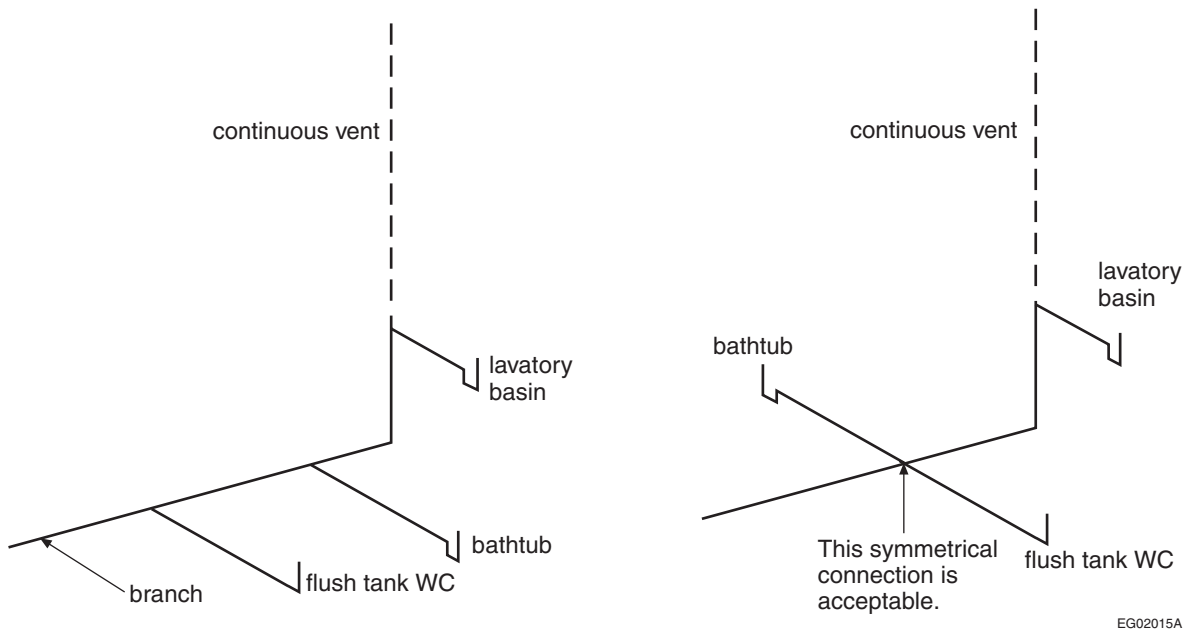


EG02014A

**Figure A-2.5.2.1.-B**  
**Example of Wet Venting Described in Clause 2.5.2.1.(1)(c)**

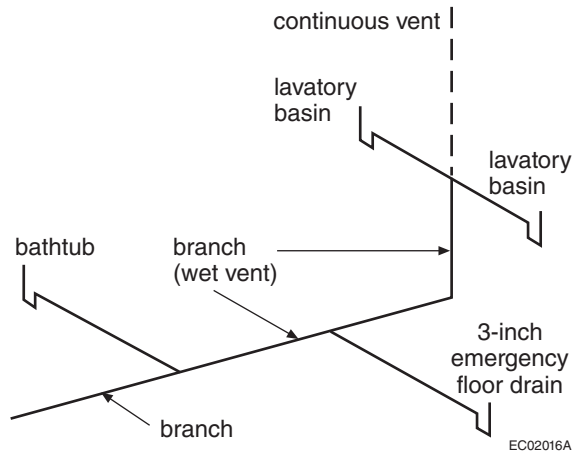
**Note to Figure A-2.5.2.1.-B:**

(1) A symmetrical connection is accomplished with a manufactured fitting that has two or more inlets and connects two or more waste lines to a vent or wet vent.

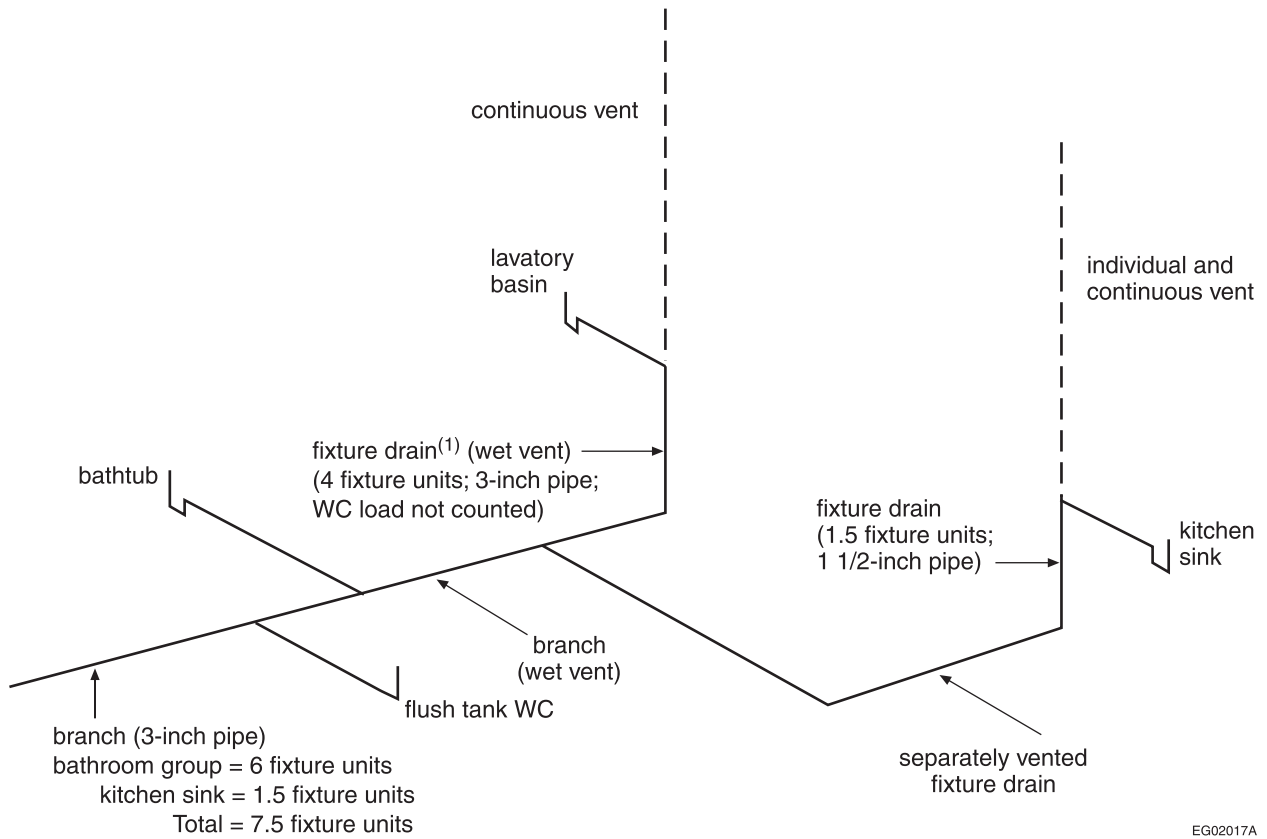


EG02015A

**Figure A-2.5.2.1.-C**  
**Example of Wet Venting Described in Clause 2.5.2.1.(1)(d)**



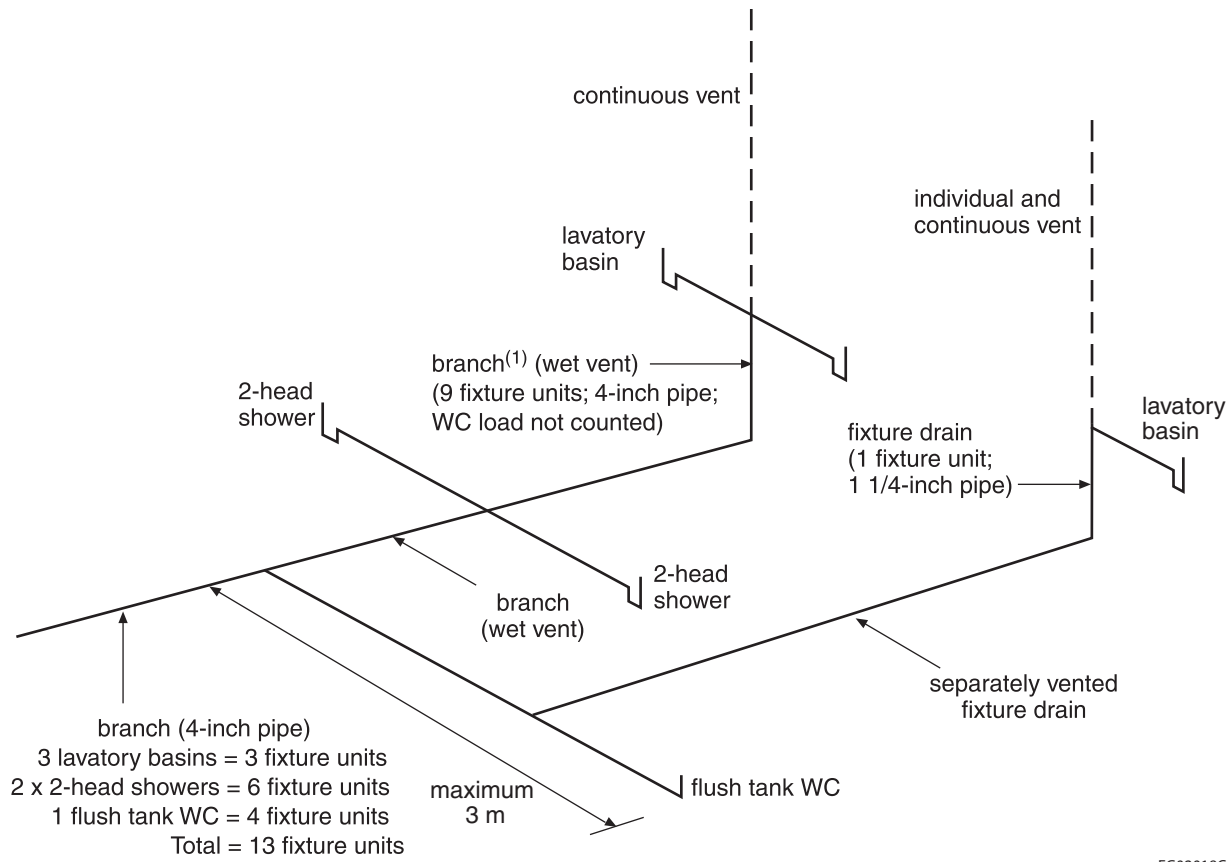
**Figure A-2.5.2.1.-D**  
**Example of Wet Venting Described in Clause 2.5.2.1.(1)(e)**



**Figure A-2.5.2.1.-E**  
**Example of Wet Venting Described in Clause 2.5.2.1.(1)(f)**

**Note to Figure A-2.5.2.1.-E:**

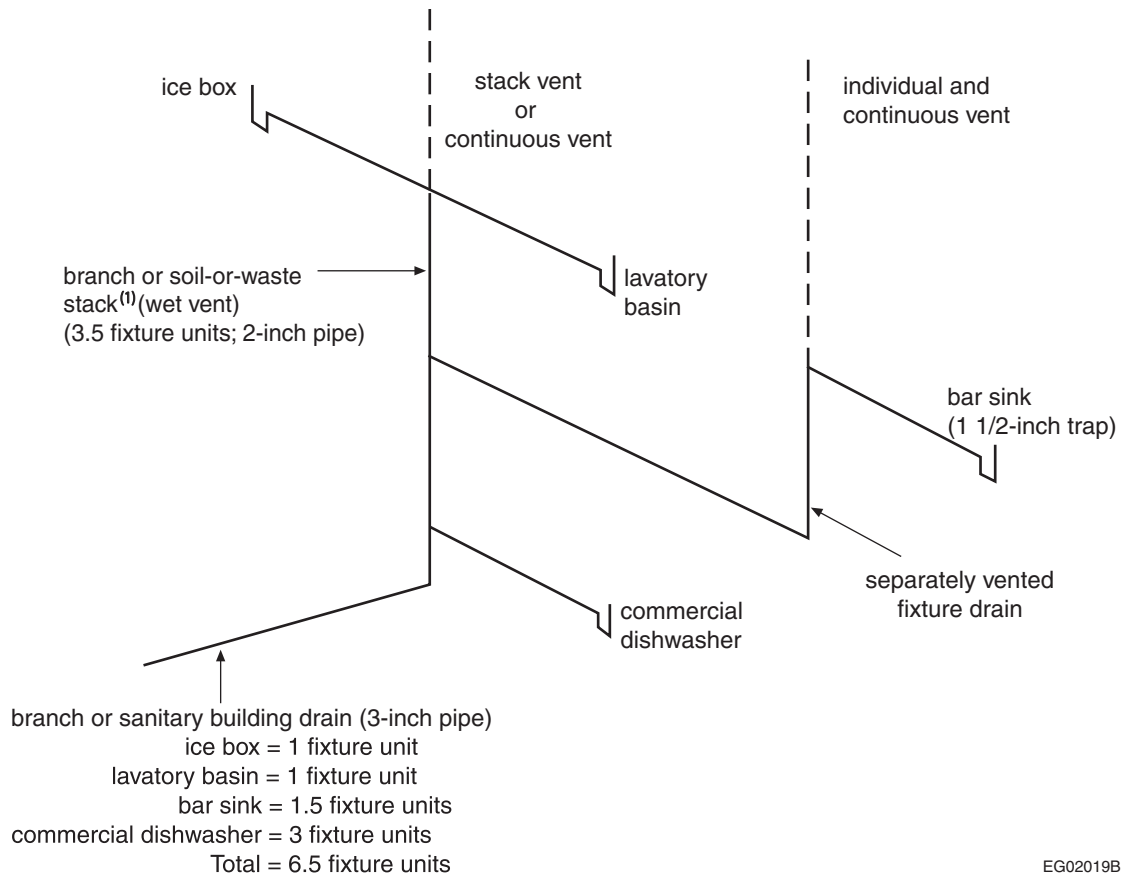
(1) The load from the separately vented kitchen sink is included when sizing this pipe.



**Figure A-2.5.2.1.-F**  
**Example of Wet Venting Described in Clause 2.5.2.1.(1)(f)**

**Note to Figure A-2.5.2.1.-F:**

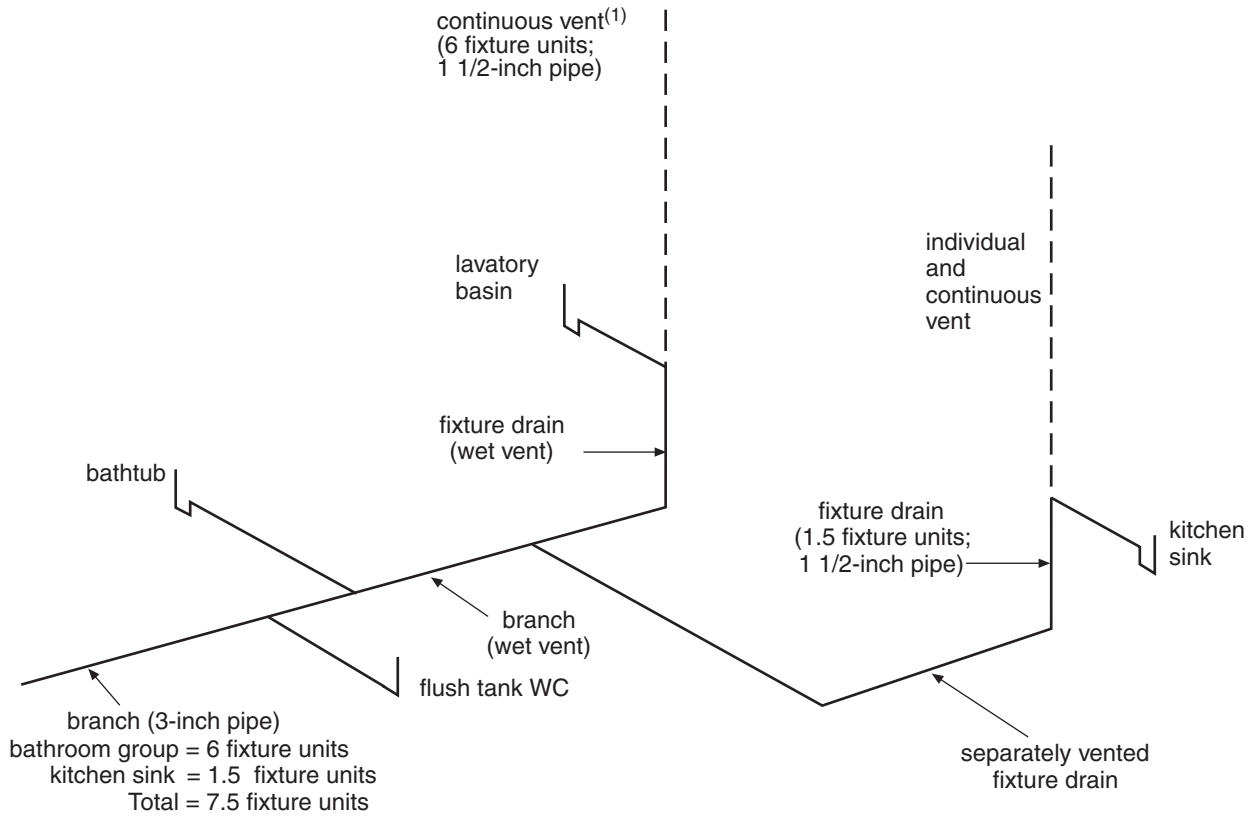
(1) The load from the separately vented lavatory basin is included when sizing this pipe.



**Figure A-2.5.2.1.-G**  
**Example of Wet Venting Described in Clause 2.5.2.1.(1)(f)**

**Note to Figure A-2.5.2.1.-G:**

(1) The load from the separately vented bar sink is included when sizing this pipe.

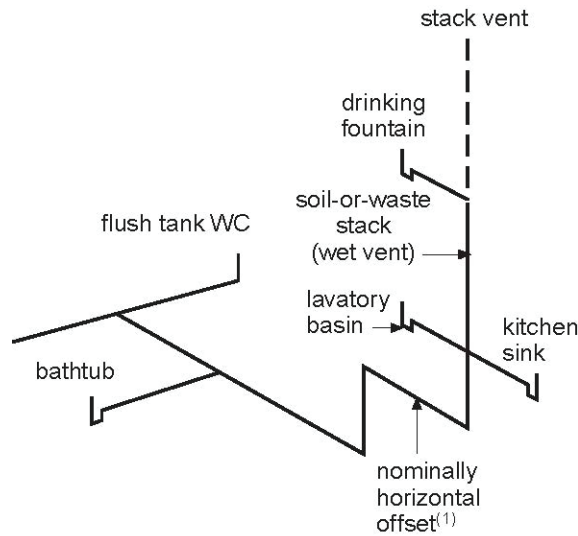


EG02020A

**Figure A-2.5.2.1.-H**  
Example of Wet Venting Described in Clause 2.5.2.1.(1)(g)

**Note to Figure A-2.5.2.1.-H:**

(1) The load from the separately vented kitchen sink is not included when sizing this pipe.



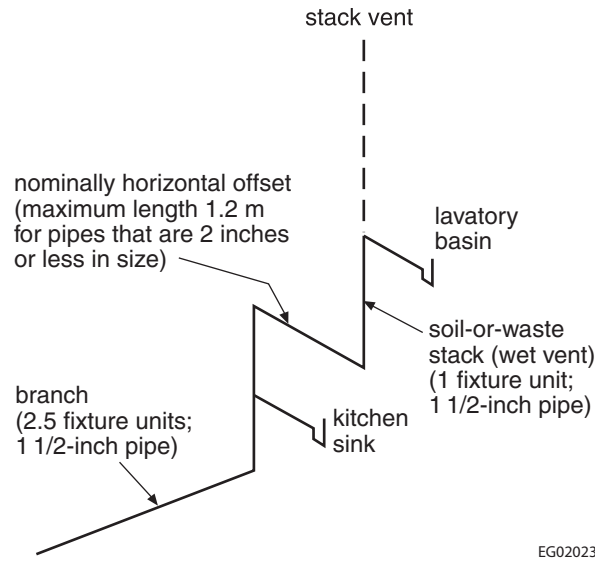
EG02022A

**Figure A-2.5.2.1.-I**  
Example of Wet Venting Described in Clause 2.5.2.1.(1)(i)

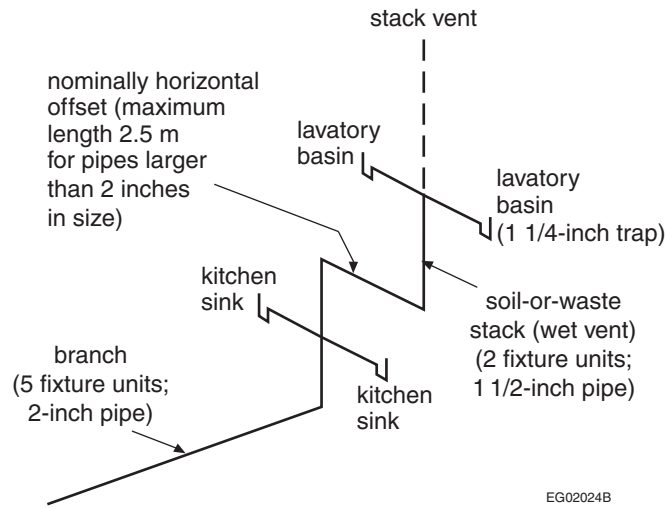
**Note to Figure A-2.5.2.1.-I:**

(1) "Offset" means the piping that connects the ends of 2 pipes that are parallel.

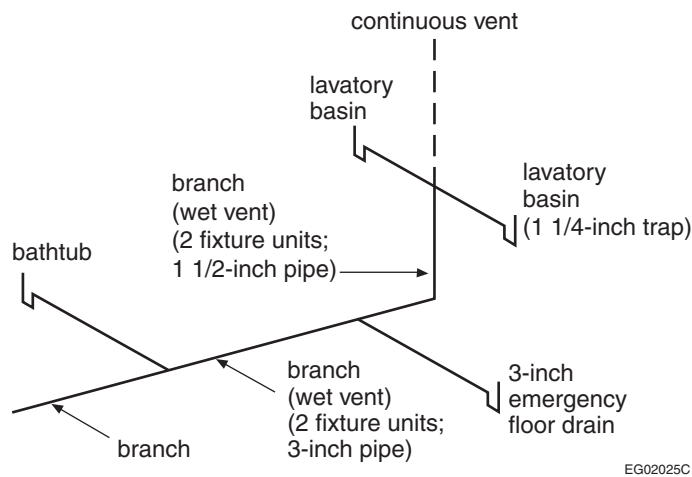




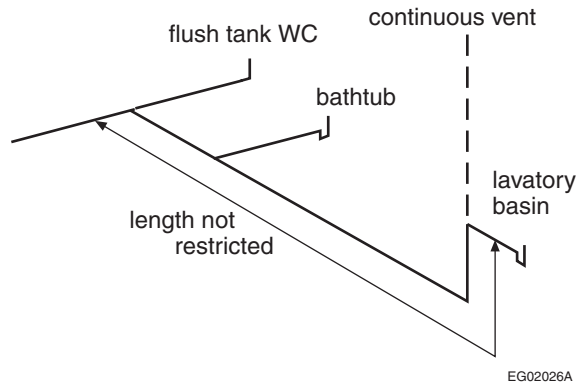
**Figure A-2.5.2.1.-J**  
Example of Wet Venting Described in Subclause 2.5.2.1.(1)(i)(i)



**Figure A-2.5.2.1.-K**  
Example of Wet Venting Described in Subclause 2.5.2.1.(1)(i)(ii)



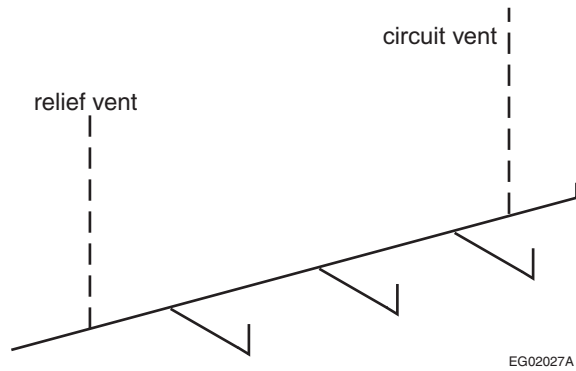
**Figure A-2.5.2.1.-L**  
Example of Wet Venting Described in Clause 2.5.2.1.(1)(j)



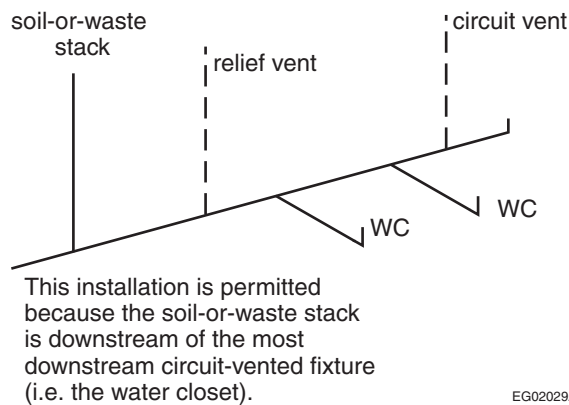
**Figure A-2.5.2.1.-M**  
**Example of Wet Venting Described in Clause 2.5.2.1.(1)(k)**

**A-2.5.3.1 Circuit Venting.** Single-storey and multi-storey wet venting has been replaced with wet venting (Article 2.5.2.1.) and circuit venting (Article 2.5.3.1.).

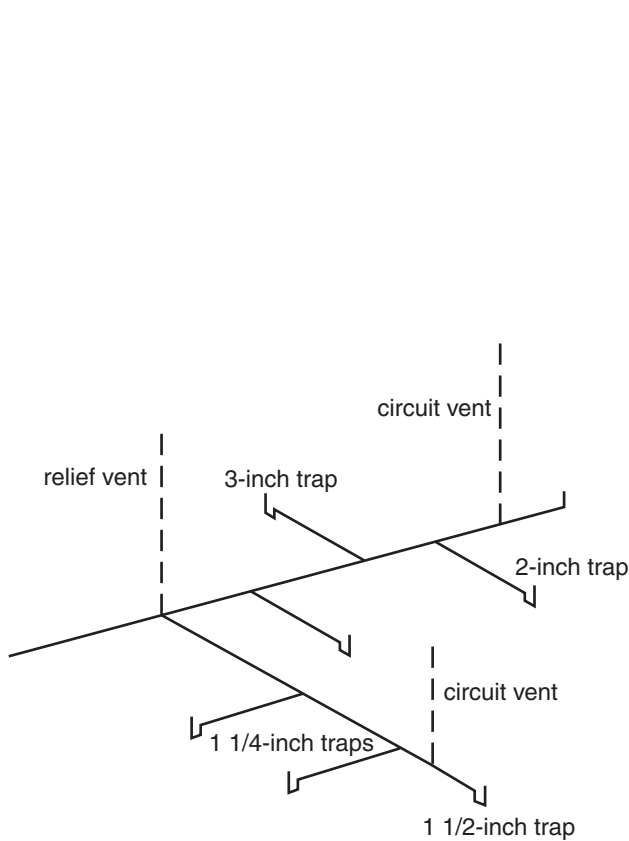
The information and figures presented in this Note are examples of the most common installation practices that meet NPC requirements. However, the examples shown do not preclude other installations that would also conform to NPC requirements.



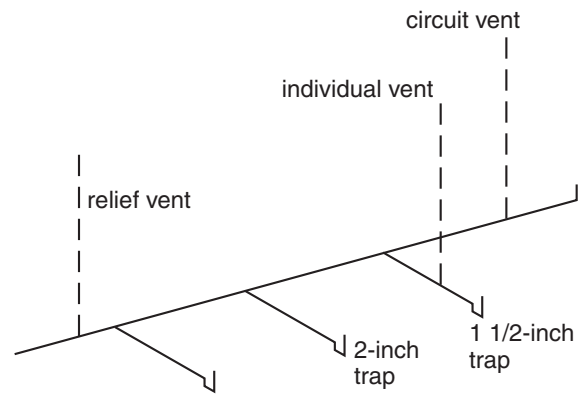
**Figure A-2.5.3.1.-A**  
**Example of Circuit Venting Described in Sentence 2.5.3.1.(1)**



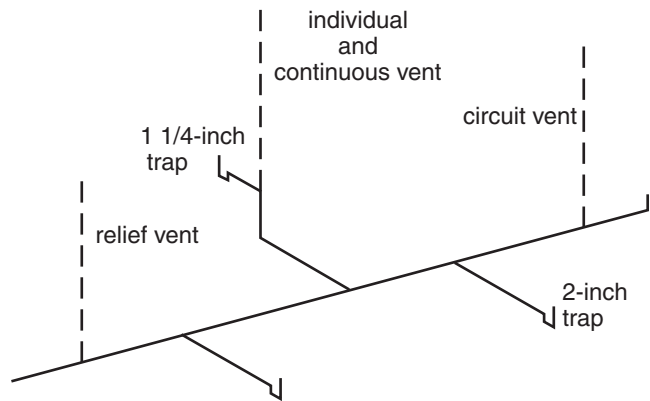
**Figure A-2.5.3.1.-B**  
**Example of Circuit Venting Described in Clause 2.5.3.1.(1)(c)**



**Example 2:** This installation is permitted because the large traps and the small traps are separately circuit-vented.



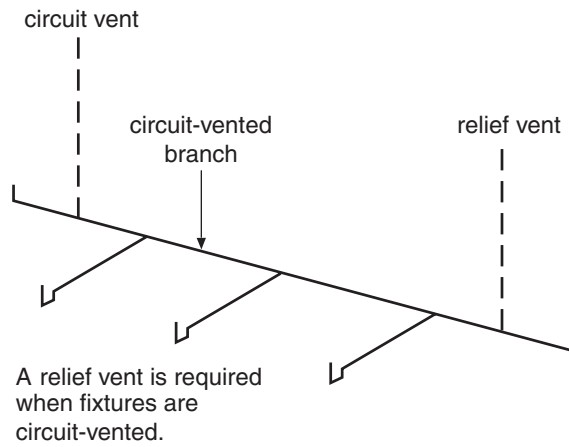
**Example 1:** This installation is permitted because the 1 1/2-inch trap is separately vented.



**Example 3:** This installation is permitted because the 1 1/4-inch trap is separately vented.

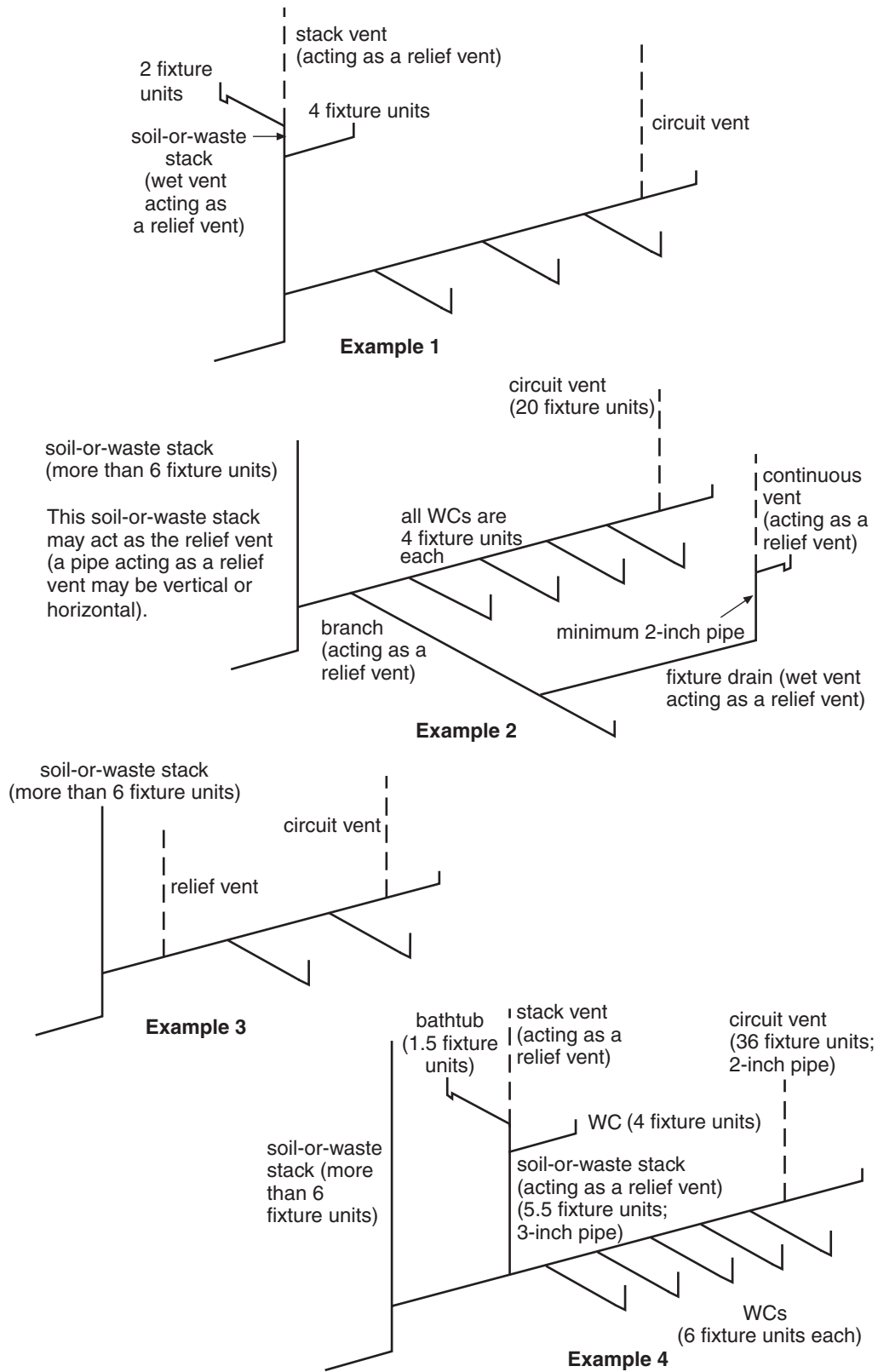
EG02030A

Figure A-2.5.3.1.-C  
 Example of Circuit Venting Described in Sentence 2.5.3.1.(2), which refers to fixture outlet pipe size



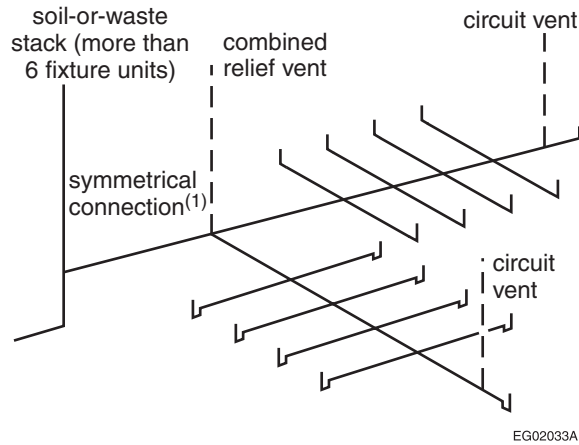
EG02031B

**Figure A-2.5.3.1.-D**  
**Example of Circuit Venting Described in Sentence 2.5.3.1.(3)**



EG02032A

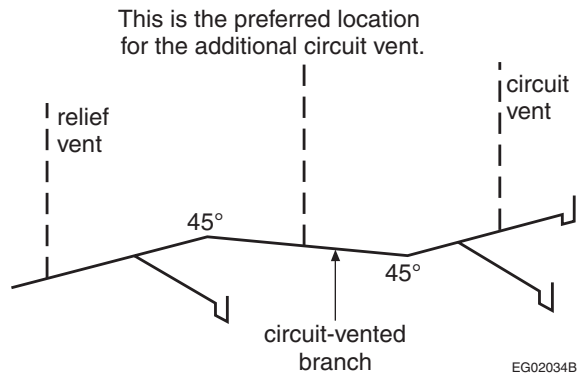
Figure A-2.5.3.1.-E  
Example of Circuit Venting Described in Sentence 2.5.3.1.(4)



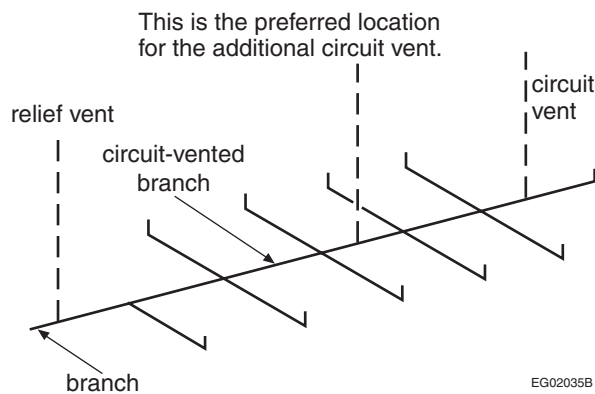
**Figure A-2.5.3.1.-F**  
**Example of Circuit Venting Described in Sentence 2.5.3.1.(5)**

**Note to Figure A-2.5.3.1.-F:**

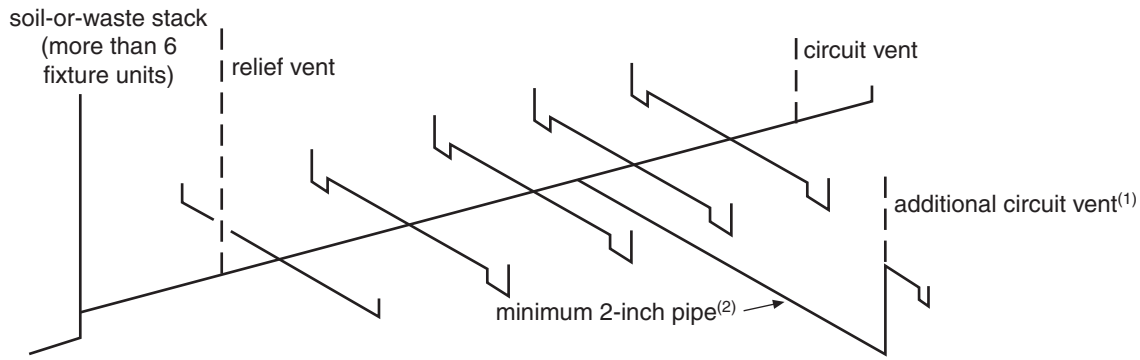
(1) A symmetrical connection is accomplished with a manufactured fitting that has two or more inlets and connects two or more waste lines to a vent or wet vent.



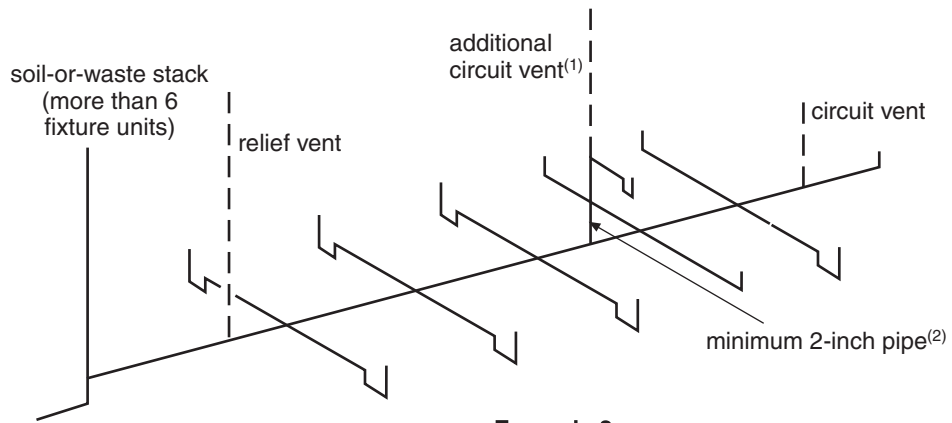
**Figure A-2.5.3.1.-G**  
**Example of Circuit Venting Described in Clause 2.5.3.1.(6)(a)**



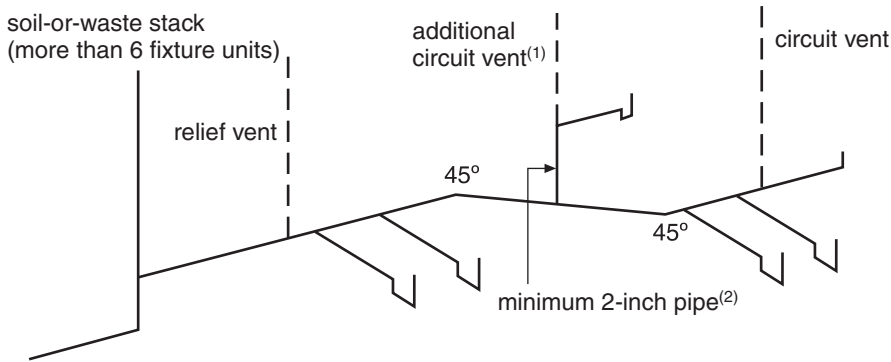
**Figure A-2.5.3.1.-H**  
**Example of Circuit Venting Described in Clause 2.5.3.1.(6)(b)**



**Example 1**



**Example 2**



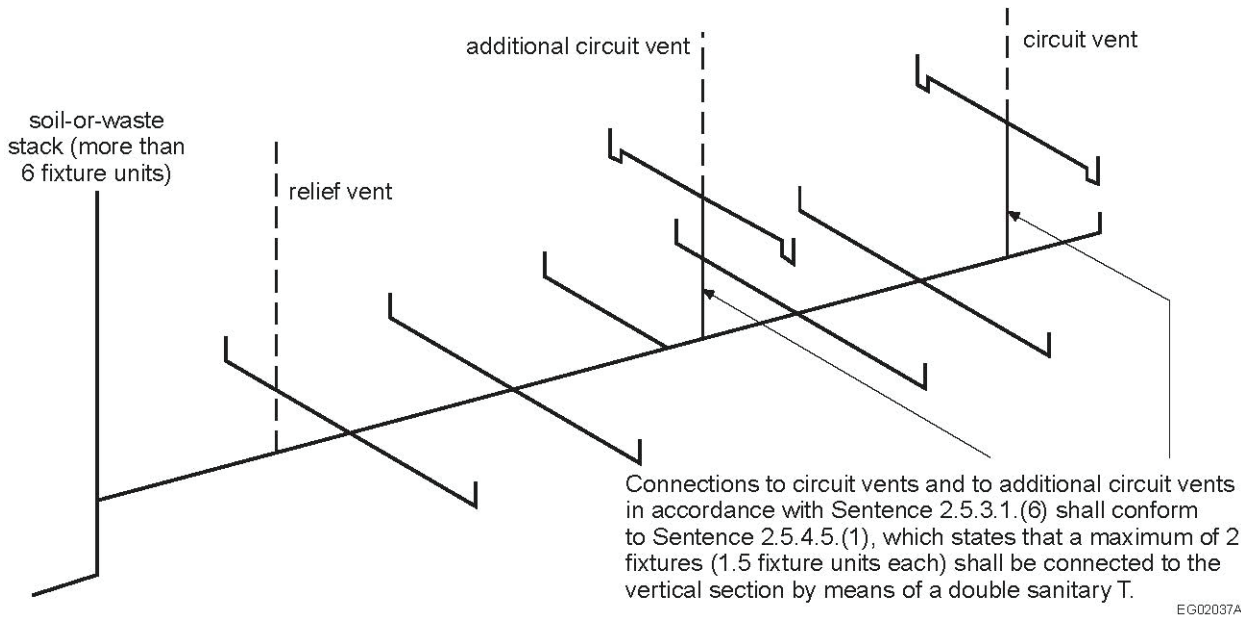
**Example 3**

EG02036A

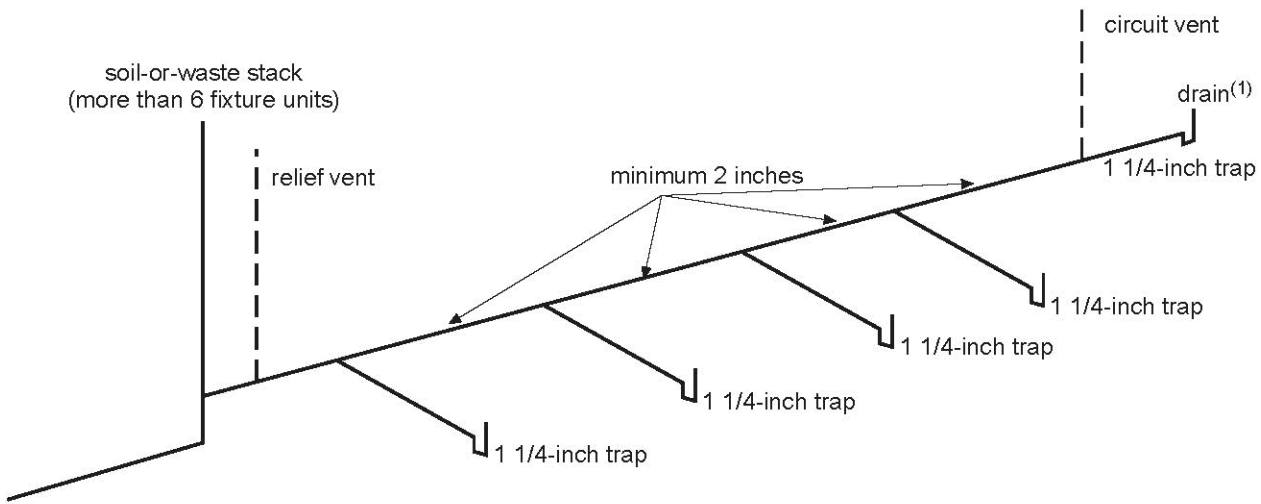
**Figure A-2.5.3.1.-I**  
**Example of Circuit Venting Described in Sentence 2.5.3.1.(7)**

**Notes to Figure A-2.5.3.1.-I:**

- (1) Size as per Article 2.5.7.1. and Sentence 2.5.7.3.(1).
- (2) See Sentence 2.5.3.1.(7).



**Figure A-2.5.3.1.-J**  
**Example of Circuit Venting Described in Sentence 2.5.3.1.(8)**

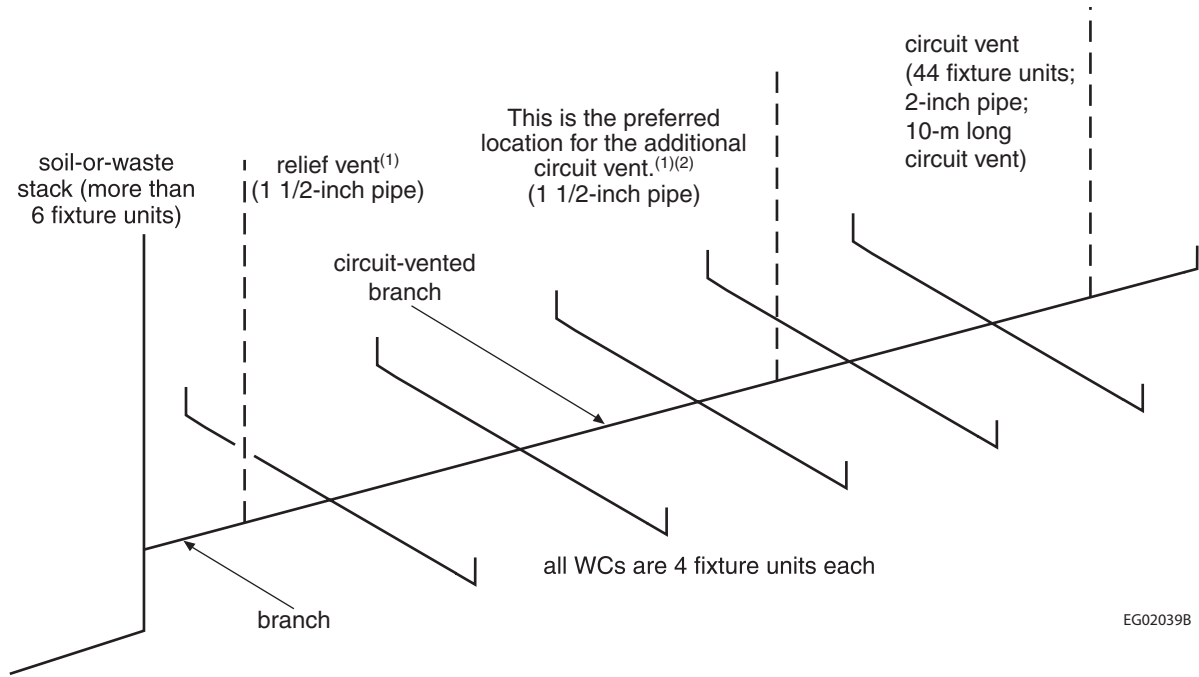


**Figure A-2.5.3.1.-K**  
**Example of Circuit Venting Described in Sentence 2.5.3.1.(9)**

**Note to Figure A-2.5.3.1.-K:**

(1) The drain is sized as a branch. The size of the drain should be increased as the load increases.



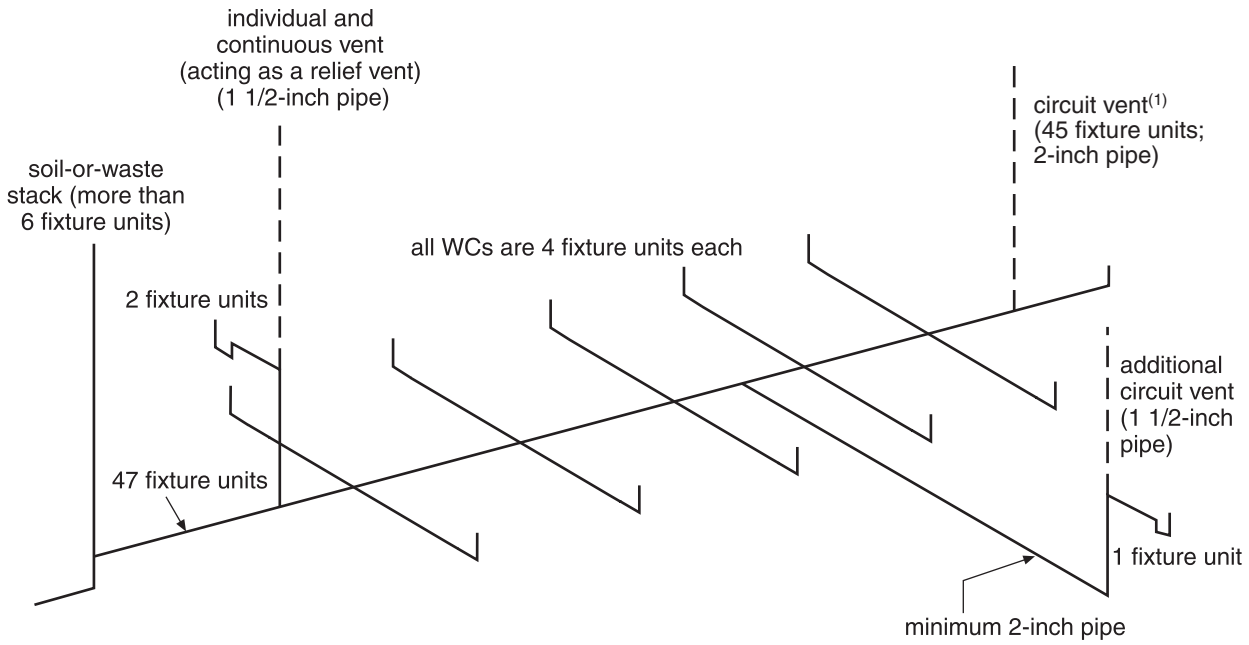


EG02039B

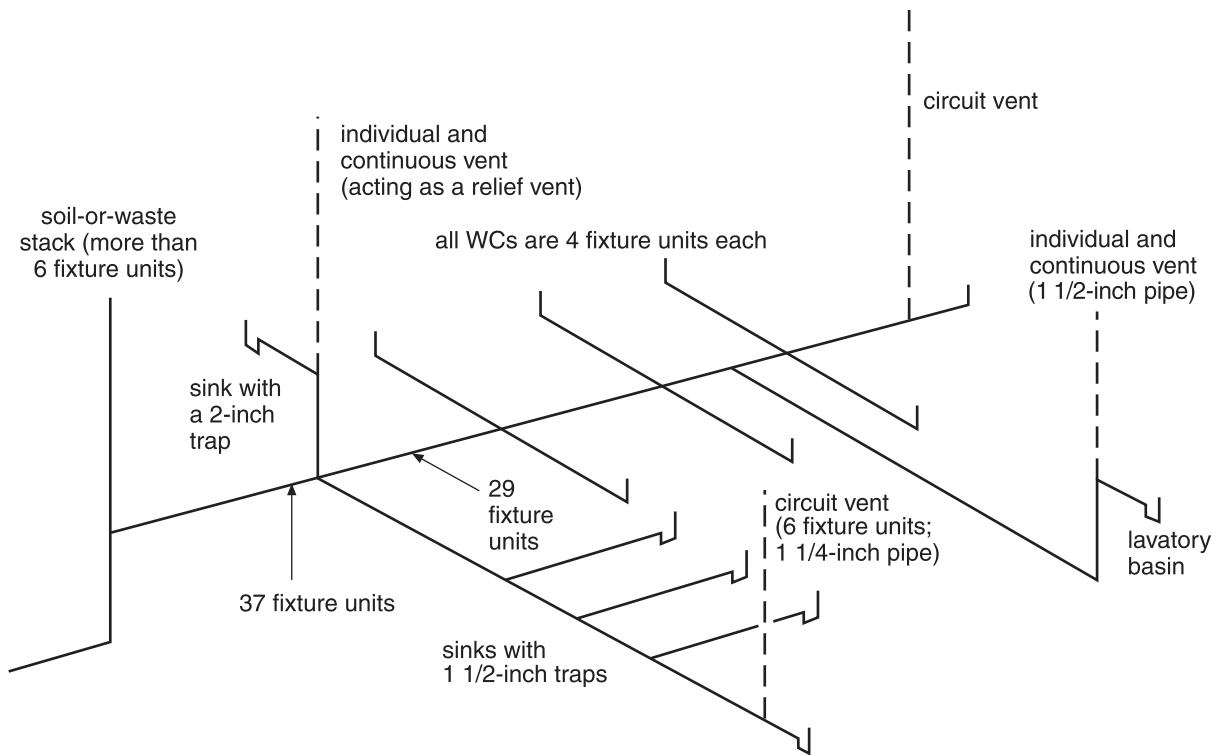
**Figure A-2.5.3.1.-L**  
**Example of Circuit Venting Described in Sentence 2.5.3.1.(10)**

**Notes to Figure A-2.5.3.1.-L:**

- (1) The relief vent and the additional circuit vent are one size smaller than the circuit vent.
- (2) See Sentence 2.5.7.3.(1).



Example 1



Example 2

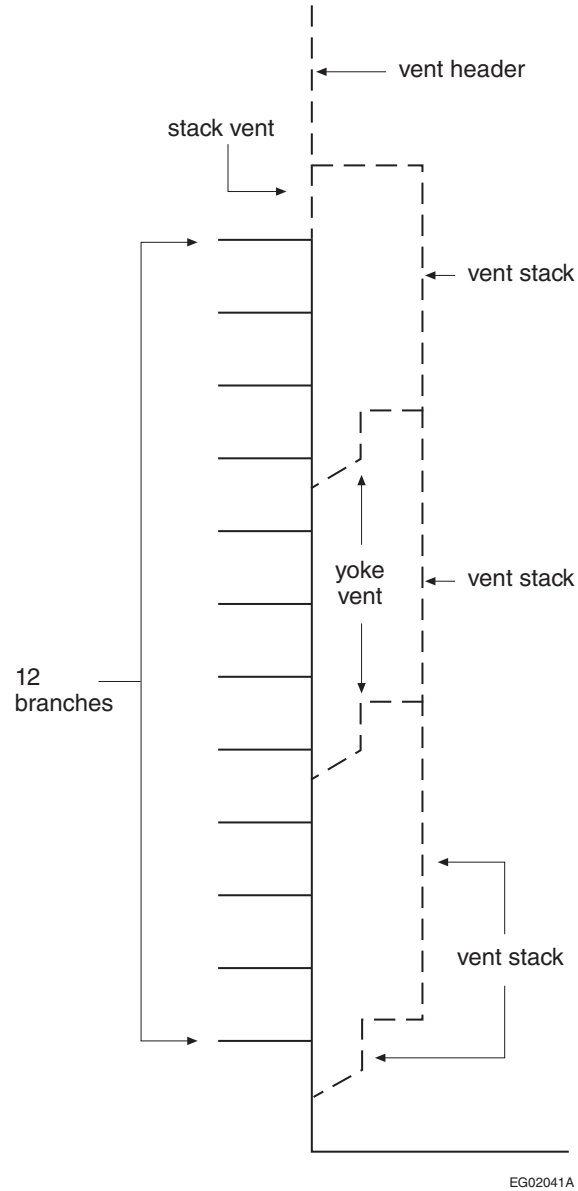
EG02040A

Figure A-2.5.3.1.-M  
Example of Circuit Venting Described in Sentence 2.5.3.1.(11)

Note to Figure A-2.5.3.1.-M:

- (1) When sizing the circuit vent, do not include fixtures with a hydraulic load of 2 fixture units that are connected downstream of the most downstream water closets.

**A-2.5.4.3 Yoke Vent.** In Ontario, yoke vents have traditionally been referred to as modified stack vents.



**Figure A-2.5.4.3.**  
**Yoke Vent**

**A-2.5.4.4.(1) Offset Relief Vents.** When an offset is greater than 1.5 m, it must be sized the same way as a branch or building drain (See Sentence 2.4.10.6.(2)). An offset relief vent is required at points A and B or A and C in Figure A-2.5.4.4.(1).

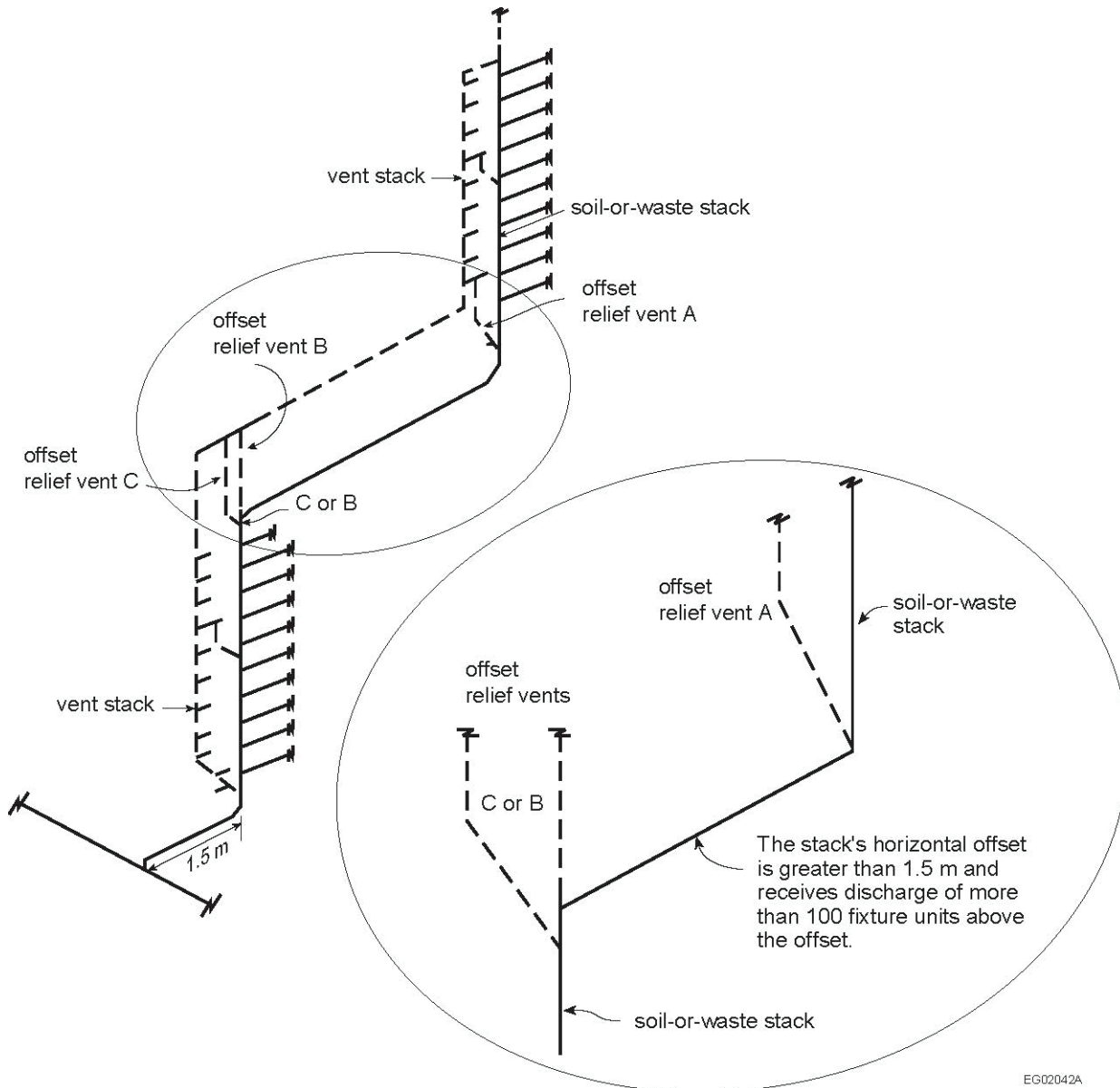
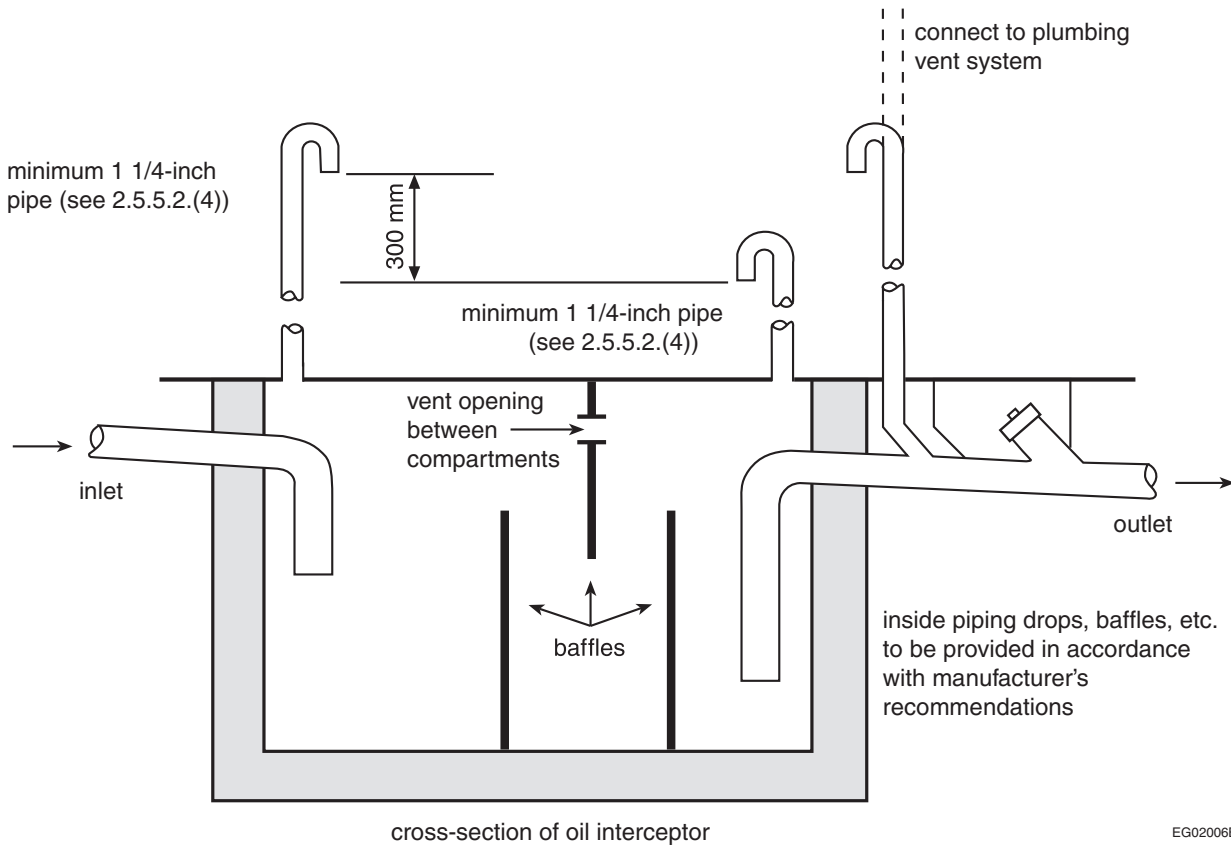


Figure A-2.5.4.4.(1)  
Offset Relief Vents

**A-2.5.4.5.(1) Fixture Connections to Vent Pipes.** When one or more fixture drains are connected to a vent pipe, the vent pipe becomes a wet vent. It must then conform to all the requirements that can apply to it as a drainage pipe and a vent pipe.

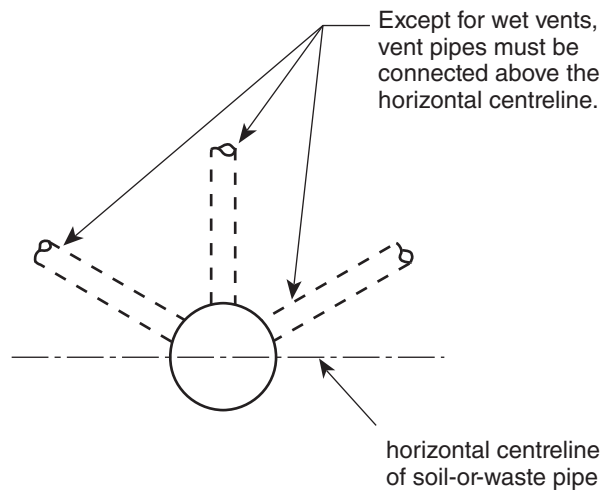
**A-2.5.5.2 Venting of Oil Interceptors.**



EG02006B Figure

**A-2.5.5.2. Venting of Oil Interceptors**

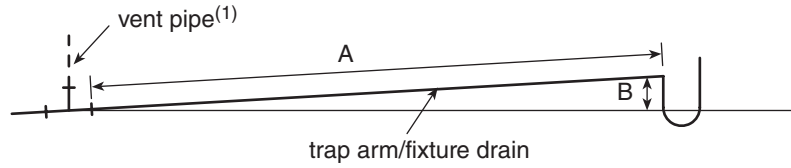
**A-2.5.6.2.(2) Vent Pipe Connections.** Fittings used to connect vent pipes to nominally horizontal soil-or-waste pipes are specified in Subsection 2.2.4.



EC01164B

**Figure A-2.5.6.2.(2) Vent Pipe Connections**

**A-2.5.6.3.(1) Vent Connection and Location of Vent Pipes.**



Developed length "A" must be at least twice the size of the trap arm/fixture drain.

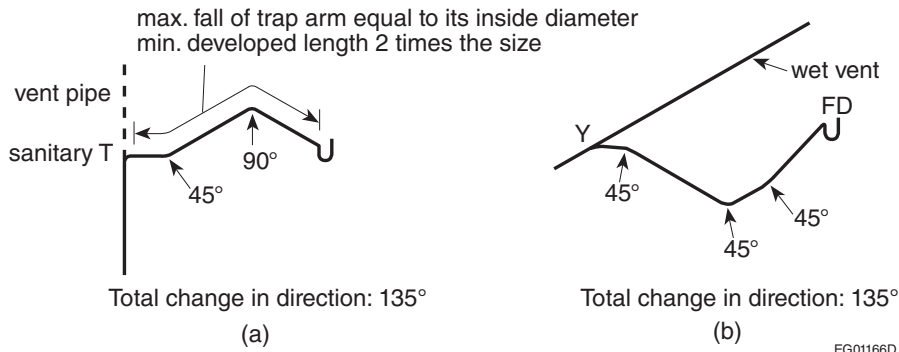
Fall "B" must not be greater than the inside diameter of the trap arm/fixture drain.

EG01165C

**Figure A-2.5.6.3.(1)-A  
Vent Connection**

**Note to Figure A-2.5.6.3.(1)-A:**

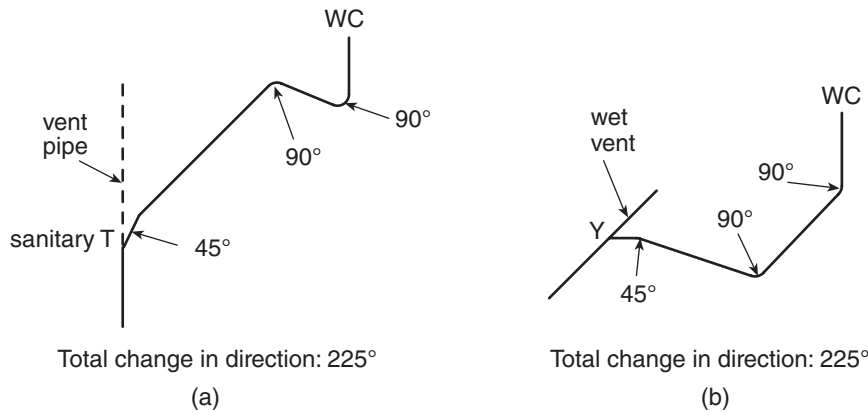
(1) The vent pipe must be connected in accordance with Article 2.5.6.2.



EG01166D

**Figure A-2.5.6.3.(1)-B  
Location of Vent Pipes That Protect Fixture Traps and Maximum Change in Direction of Trap Arms**

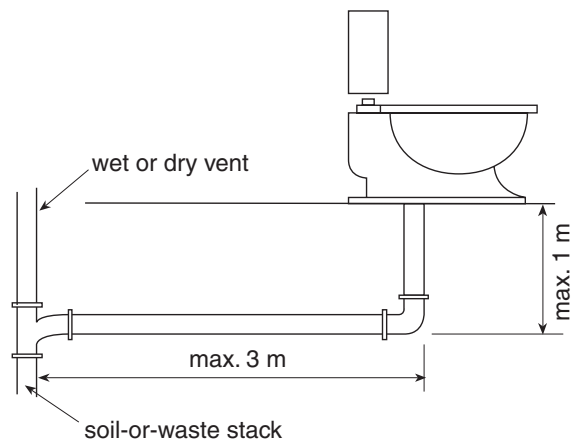
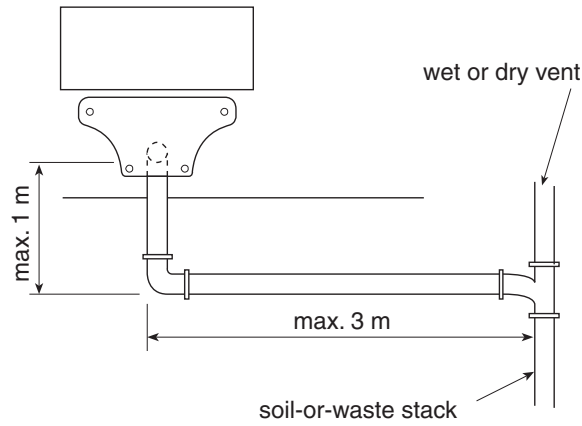
**A-2.5.6.3.(2) Location of Vent Pipes.**



EG01166C

**Figure A-2.5.6.3.(2)  
Location of Vent Pipes and Maximum Change in Direction of Trap Arms for Fixtures That Depend on Siphonic Action**

**A-2.5.6.3.(3) Length of WC Fixture Drain.**



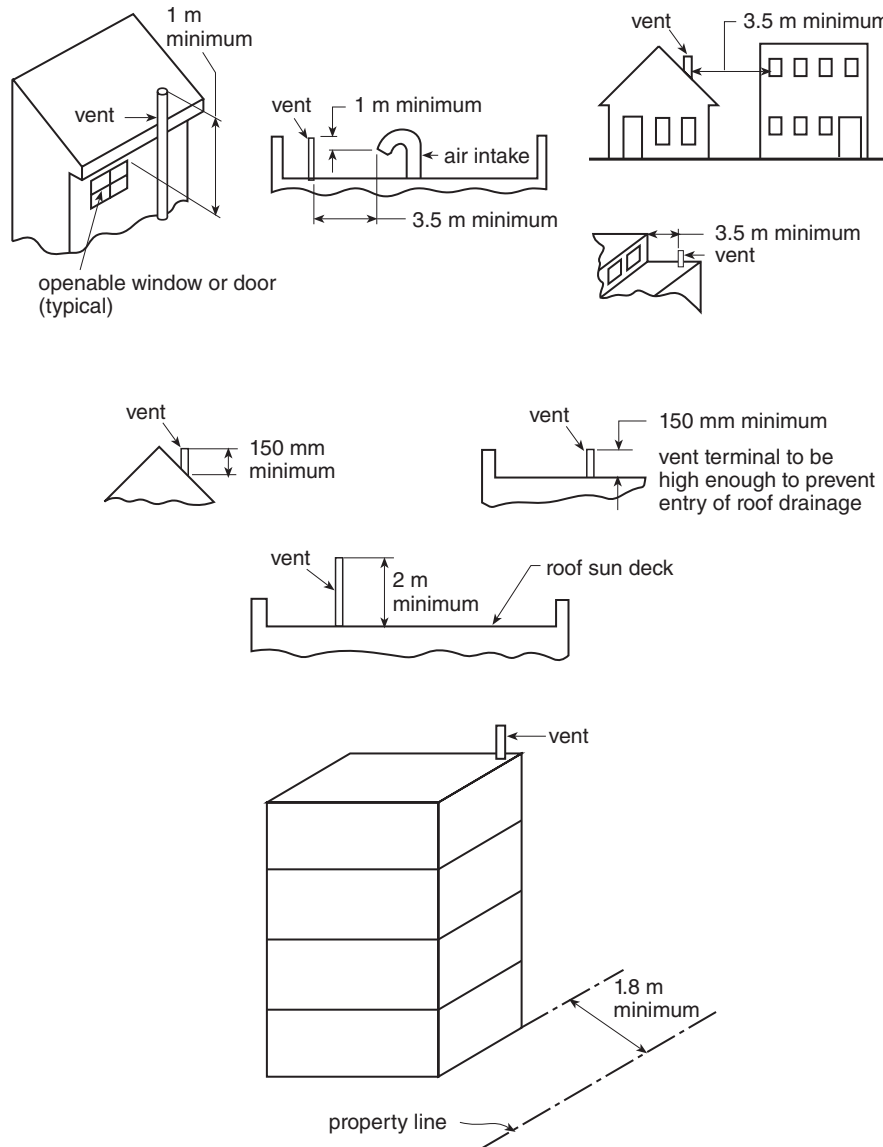
EC01167A

**Figure A-2.5.6.3.(3)**  
**Length of WC Fixture Drain**

**Note to Figure A-2.5.6.3.(3):**

(1) Fall and length of WC fixture drain applies to floor-mounted and wall-hung WC's.

**A-2.5.6.5.(4) Vent Terminals.** No vent pipe other than a fresh air inlet may terminate within the limits indicated.



EC00664B

**Figure A-2.5.6.5.(4)**  
**Vent Terminals**

**A-2.5.8. Sizing of Venting Systems.** Vent pipes are connected to the drainage system and terminate outside the building. They allow air to enter and circulate and they protect the trap seals in the drainage system. Except as permitted in Subsection 2.5.1., a trap shall always be protected by a vent pipe.

### Sizing of Vent Pipes

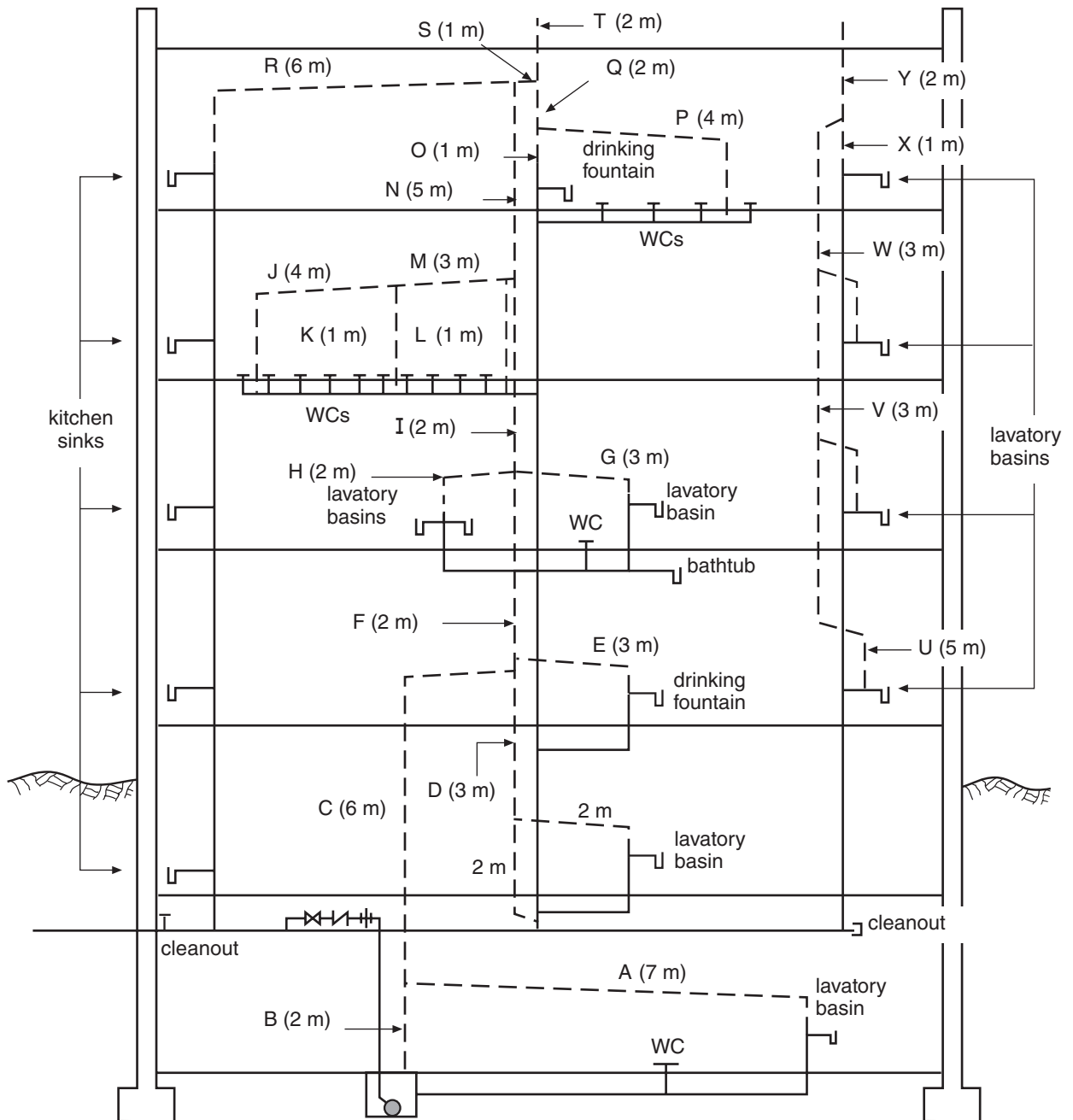
The sizes stated in Table 2.5.7.1. take precedence over all other venting tables.

### Sizing of Relief Vents

Length is not taken into consideration when sizing a relief vent and an additional circuit vent. A relief vent connected to a circuit-vented branch is sized according to Sentences 2.5.7.3.(1) and (2).

An offset relief vent is sized according to Sentence 2.5.7.4.(1), which permits the offset relief vent to be one size smaller than the stack vent.





EG02043A

**Figure A-2.5.8.**  
**Sizing of a Venting System**

**Notes to Figure A-2.5.8.:**

- (1) All water closets are 4 fixture units each.
- (2) The letters in columns 1 and 3 of Table A-2.5.8. correspond to the letters in this Figure.

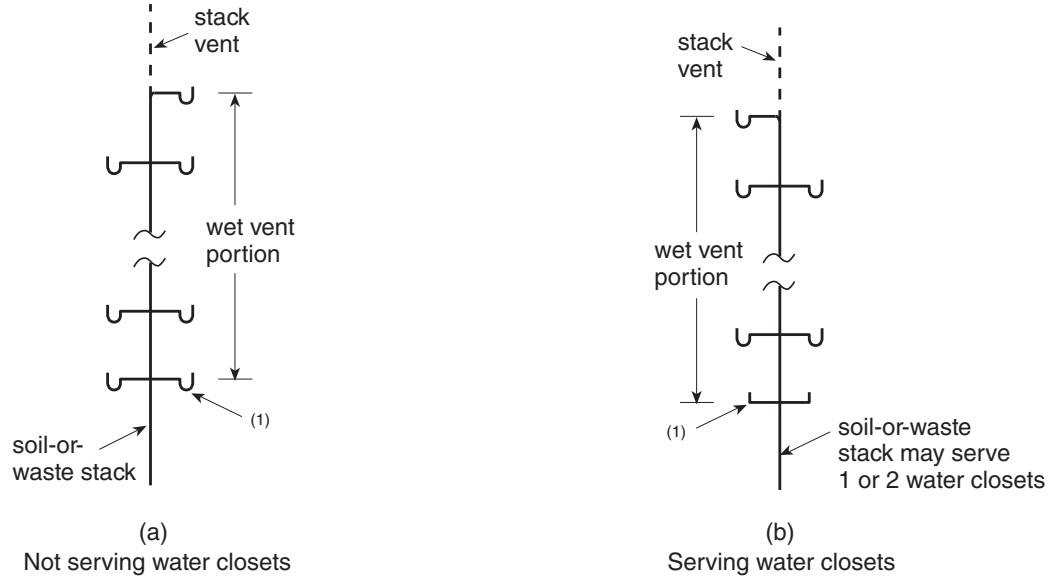
**Table A-2.5.8.**  
**Sizing of Venting Systems**  
 Forming Part of Note A-2.5.8.

Vent Pipe <sup>(1)</sup>	Vent Name	Developed Length Used to Determine Size, m <sup>(1)</sup>	Hydraulic Load Used to Determine Size, fixture units	Code Reference	Minimum Size, inches
A	Continuous vent	A+C=13	5	2.5.7.1.	1½
B	Sump vent	n/a	n/a	2.5.7.7.(1)	2
C	Branch vent	A+C=13	5	2.5.7.7.(2)	2
D	Vent stack	2+D+F+I+N+S+T=17	66	2.5.7.1. 2.5.7.2.	3
E	Individual and continuous vent	n/a	n/a	2.5.7.1.	1¼
F	Vent stack	Same as D=17	71	Same as D	3
G	Continuous vent	G=3	6	2.5.8.3.(5) 2.5.7.1.	1½
H	Dual and continuous vent	n/a	n/a	2.5.7.1.	1¼
I	Vent stack	Same as D=17	71	Same as D	3
J	Circuit vent	J+M=7	40	2.5.7.1. 2.5.8.3.(4)	1½
K	Additional circuit vent	n/a	n/a	2.5.7.1. 2.5.7.3.(1)	1½
L	Relief vent	n/a	n/a	2.5.7.1. 2.5.7.3.(1)	1½
M	Branch vent	J+M=7	40	2.5.7.1. 2.5.7.2.	1½
N	Vent stack	Same as D=17	71	Same as D	3
O	Stack vent	O+Q+T=5	66	2.5.7.1. 2.5.8.4.	2
P	Circuit vent	P=4	16	2.5.7.1. 2.5.8.3.(4)	1½
Q	Stack vent	Same as O=5	66	2.5.7.1. 2.5.8.4.	2
R	Stack vent	R+S+T=9	7.5	2.5.2.1.(1)(a)	3
S	Vent header	A+C+F+I+N+S+T=25	78.5	2.5.8.3.(3)	3
T	Vent header	Same as S=25	78.5	2.5.8.3.(3)	3
U	Individual vent	n/a	n/a	2.5.7.1.	1¼
V	Branch vent	U+V+W=11	2	2.5.7.1. 2.5.7.2.	1¼
W	Branch vent	Same as V=11	3	2.5.7.1. 2.5.7.2.	1¼
X	Stack vent	X+Y=3	4	2.5.7.1. 2.5.8.4.	1¼
Y	Stack vent	Same as X=3	4	2.5.7.1. 2.5.8.4.	1¼

**Notes to Table A-2.5.8.:**

(1) The letters in columns 1 and 3 correspond to the letters in Figure A-2.5.8.

**A-2.5.8.1.(2) Sizing of Wet Vent Systems.**



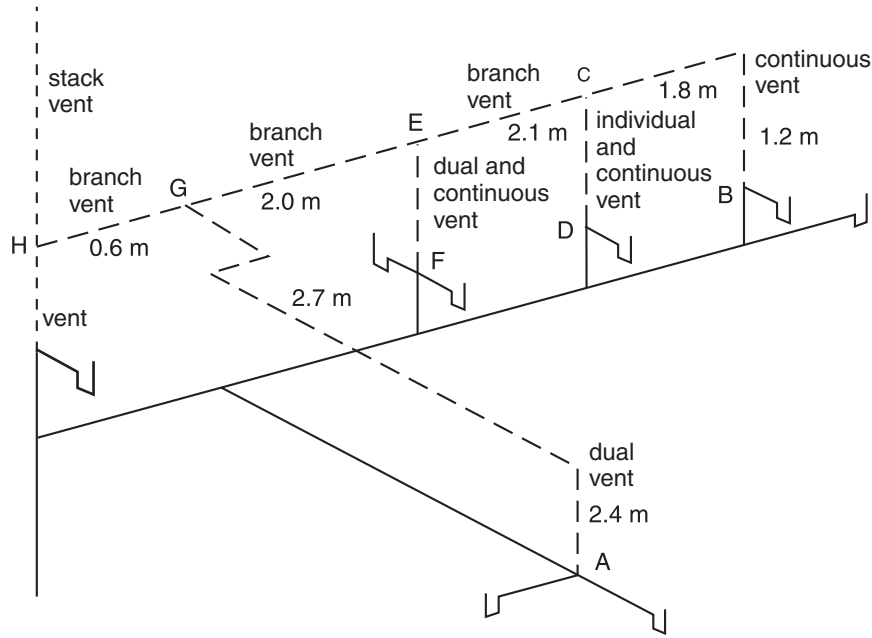
EG01171B

**Figure A-2.5.8.1.(2)**  
**Sizing of Wet Vent Systems**

**Note to Figure A-2.5.8.1.(2):**

(1) These two fixtures are not included when determining the size of the wet vent portion using Table 2.5.8.1.

**A-2.5.8.3. and 2.5.8.4. Lengths to be Considered When Sizing Vent Pipes.**



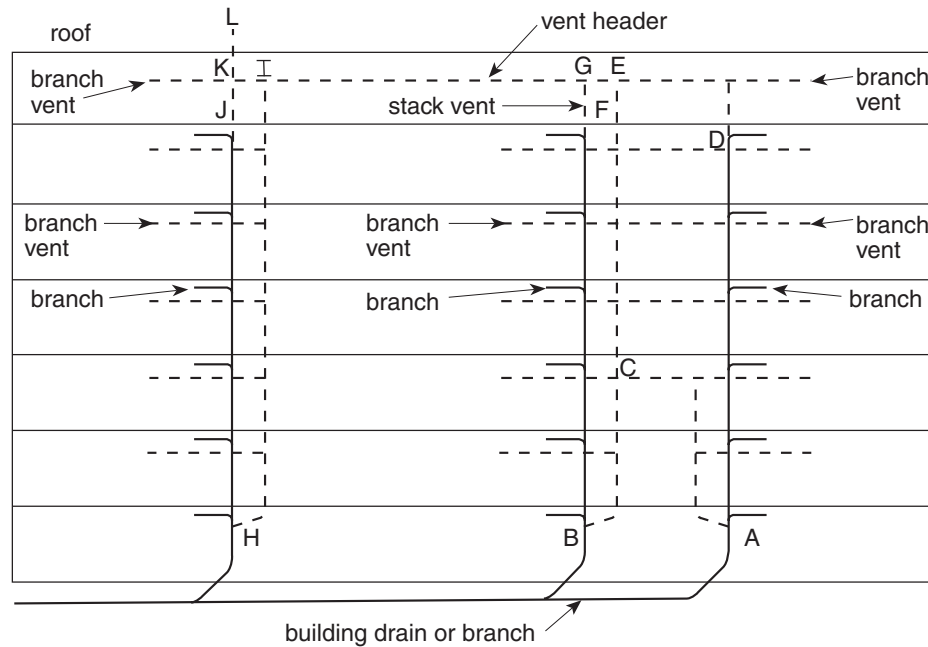
<u>Vent</u>	<u>Length (for sizing purposes)</u>	<u>NPC Reference</u>
Dual vent (A-G)	Vent length not applicable	Note 1
Continuous vent (B-C)	BCEGH 1.2 + 1.8 + 2.1 + 2.0 + 0.6 = 7.7	Note 2
Individual and continuous vent (D-C)	Vent length not applicable	Note 1
Branch vent (C-E)	BCEGH 1.2 + 1.8 + 2.1 + 2.0 + 0.6 = 7.7	Note 2
Dual and continuous vent (F-E)	Vent length not applicable	Note 1
Branch vent (E-G)	BCEGH 1.2 + 1.8 + 2.1 + 2.0 + 0.6 = 7.7	Note 2
Branch vent (G-H)	BCEGH 1.2 + 1.8 + 2.1 + 2.0 + 0.6 = 7.7	Note 2

EG01172B

**Figure A-2.5.8.3. and 2.5.8.4.-A**  
**Lengths to be Considered When Sizing Vent Pipes**

**Notes to Figure A-2.5.8.3. and 2.5.8.4.-A:**

- (1) See Article 2.5.8.2.
- (2) See Article 2.5.8.3.



Vent pipe	Length to be considered
Vent stack (A-C)	ACEGIKL <sup>(1)</sup>
Vent stack (B-C)	BCEGIKL <sup>(1)</sup>
Vent stack (H-I)	HIKL <sup>(1)</sup>
Stack vent (D-E)	DEGIKL <sup>(1)</sup>
Stack vent (F-G)	FGIKL <sup>(1)</sup>
Stack vent (J-K)	JKL <sup>(1)</sup>
Vent header or any section of it (CEGIKL)	ACEGIKL <sup>(2)</sup>

EG01173B

**Figure A-2.5.8.3. and 2.5.8.4.-B**  
**Lengths to be Considered When Sizing Vent Pipes**

**Notes to Figure A-2.5.8.3. and 2.5.8.4.-B:**

- (1) See Sentence 2.5.8.4.(2).
- (2) See Sentence 2.5.8.3.(3).

**A-2.6.1.3.(5) Shut-off Valves.** Where multiple risers convey the water supply to dwelling units, each dwelling unit's water distribution system shall be provided with a shut-off valve located immediately where the water piping enters the suite so as to isolate the fixtures as well as the water distribution piping serving the dwelling unit's fixtures. Fixture stopcocks or shut-off valves located immediately adjacent to a fixture may not be adequate to protect the water distribution piping. Where a dwelling unit is served by a single shut-off valve on the water supply, additional shut-off valves may be required to achieve compliance with Sentences 2.6.1.3.(4) and (7).

**A-2.6.1.6.(5) Flush-Tank-Type Urinals in Seasonal Buildings.** Flush-tank-type urinals that are not in use for an extended period of time, such as those in seasonal buildings, are permitted to be set up to flush automatically at predetermined intervals. Automatic flushing prevents the depletion of the water seal due to evaporation or backflow conditions. The trap seal restricts the infiltration of gases, which can pose health and safety concerns.

**A-2.6.1.7.(5) Relief Valves.** If the discharge piping is longer than 2 m or more than two 90° elbows are used, the valve manufacturer's installation instructions should be followed to ensure that the piping does not affect the relief valves' discharge capacity.

**A-2.6.1.9.(1) Water Hammer Prevention.** Water hammer is a buildup of pressure in a length of horizontal or vertical pipe that occurs when a valve or faucet is closed suddenly. The longer the pipe and the greater the water velocity, the greater the pressure exerted on the pipe, which can be many times the normal static water pressure and be sufficient to damage the piping system. Since air chambers made from a piece of vertical pipe do not provide acceptable protection, pre-manufactured water hammer arresters are required to address this potential problem. Water hammer arresters need not be installed at every valve or faucet, nor in every piping system.

**A-2.6.1.11.(1) Thermal Expansion.** To accommodate the increase in pressure caused by thermal expansion within a closed water distribution system, one of the following should be installed:

- (1) a suitably sized diaphragm expansion tank designed for use within a potable water system,
- (2) an auxiliary thermal expansion relief valve (T.E.R. valve) conforming to CSA B125.3, “Plumbing Fittings,” set at a pressure of 550 kPa or less and designed for repeated use, or
- (3) other means acceptable to the authority having jurisdiction.

**A-2.6.1.12.(1) Service Water Heaters.** Storing hot water at temperatures below 60°C in the hot water tank or in the delivery system may lead to the growth of legionella bacteria.

Rev.  
12717

**A-2.6.2.1.(3) Deleted.**

**A-2.6.2.4.(2) Backflow from Fire Protection Systems.** The following document is considered to be good engineering practice when selecting a backflow preventer for installation on a fire protection system: AWWA M14, “Recommended Practice for Backflow Prevention and Cross-Connection Control.”

**Table A-2.6.2.4.(2)**  
**Selection Guide for Backflow Prevention Devices on Fire Sprinkler and Standpipe Systems**  
Forming Part of Sentence 2.6.2.4.(2)

CSA Standard Number	Type of Device <sup>(1)</sup>	Systems Made with Potable Water System Materials		Systems Not Made with Potable Water System Materials	
		Minor Hazard – Residential Partial Flow-Through System	Minor Hazard – Class 1 System	Moderate Hazard – Class 1, 2, 3 and 6 Systems	Severe Hazard – Any Class of System in which Antifreeze or Other Additives Are Used
CSA B64.6.1	DuCF	P	NP	NP	NP
CSA B64.9	SCVAF	P	P	NP	NP
CSA B64.5.1	DCVAF	P	P	P	NP
CSA B64.4.1	RPF	P	P	P	P

NP = Not permitted    P = Permitted

**Notes to Table A-2.6.2.4.(2):**

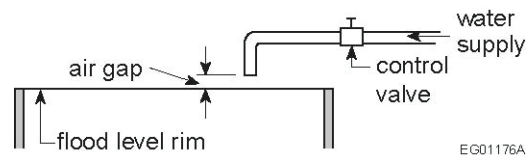
- (1) The “F” indicates that the product is only recommended for use on fire sprinkler and standpipe systems.

**A-2.6.2.4.(3) Deleted.**

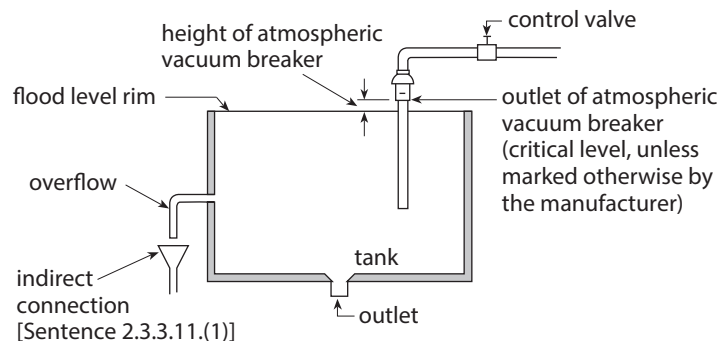
**A-2.6.2.6.(1) Locations Requiring Premise Isolation.** The following list is a guide to locations where premise isolation may be required:

- hospital buildings with operating, mortuary or laboratory facilities
- radioactive material processing plants
- petroleum processing facilities
- premises where inspection is restricted
- sewage treatment plants
- commercial laundries (excluding laundromats)
- plating or chemical plants
- docks and dockside facilities
- food and beverage processing plants
- steam plants
- trackside facilities for trains

An assessment of the hazard must be carried out to determine the need, if any, for a backflow prevention device.

**A-2.6.2.9.(2) Installation of Air Gaps.**

**Figure A-2.6.2.9.(2)**  
Installation of Air Gaps

**A-2.6.2.10.(2) Installation of Atmospheric Vacuum Breakers.**

**Figure A-2.6.2.10.(2)**  
Installation of Atmospheric Vacuum Breakers

**A-2.6.3. Water Systems.** Subsection 2.6.3. contains performance requirements for water systems. Two widely used references for the design of water systems are:

NIST Building Materials and Structures Report BMS-79, “Water-Distributing Systems for Buildings,” United States Department of Commerce, National Bureau of Standards, Washington, D.C., and

McGraw-Hill 2009, “International Plumbing Codes Handbook,” edited by V.T. Manas, McGraw-Hill Book Company, New York, U.S.A.

**A-2.6.3.1. Water Quality.** Water destined for use as potable water can originate from a variety of sources that are generally classified as surface waters or well waters, such as lakes, rivers, streams and aquifers. In some localities, there may be seasonal variations in the water supply, and surface and well waters may be blended at times.

Water composition is the primary consideration in determining the cause of corrosion in potable water systems. If the water has corrosive characteristics, water treatment may be necessary to control its corrosiveness: this may be as straightforward as adjusting the pH of the water at the treatment plant, or it may involve more extensive corrosion-control treatment methods. Water purveyors normally consult treatment specialists to develop methods suitable for specific conditions. The treatment of water from private wells may also require expert consultation.

The past performance of plumbing materials and products in different localities often provides insight into what can be expected with new installations. In areas where water-related corrosion is known to occur, adjustment of water chemistry may be sufficient or it may be necessary to select alternative piping and fitting materials or more robust products.

It is important to note that not all corrosion can be attributed to water conditions: the improper design and installation of potable water systems may result in erosion corrosion, galvanic corrosion, fatigue cracking, and so forth.

**A-2.6.3.1.(2) Potable Water Systems.** The design procedures contained in the following documents are considered good engineering practice in the field of potable water systems:

- ASHRAE 2011, “ASHRAE Handbook – HVAC Applications,” chapter on Service Water Heating,
- ASHRAE 2013, “ASHRAE Handbook – Fundamentals,” chapter on Pipe Sizing,
- ASPE 2010, “Plumbing Engineering Design Handbook, Volume 2,” chapter on Cold Water Systems, and
- ASPE 2010, “Plumbing Engineering Design Handbook, Volume 2,” chapter on Domestic Water Heating Systems.

Alternatively, the following methods, which apply to both public and private water supplies, may be used in determining the size of each section of the water system using Table A-2.6.3.1.(2)-A (Small Commercial Building Method) and Table A-2.6.3.1.(2)-F (Average Pressure Loss Method). Where these methods are considered an alternative to a detailed engineering design method, the hydraulic loads shall be the sum of the total fixture units given in Tables 2.6.3.2.-A, 2.6.3.2.-B, 2.6.3.2.-C and 2.6.3.2.-D.

### Method for Small Commercial Buildings

Information required if using this method:

- a) The developed length:
  - i) from the property line or private water supply system when located outside the building to the water service entry point to the building, and
  - ii) from the water service entry point to the building to the most remote water outlet.
- b) Minimum static pressure:
  - i) the minimum static pressure available at the property line or other water source (private water supply system), or
  - ii) where there is a wide fluctuation of pressure in the main throughout the day, the minimum static pressure available.
- c) Pressure losses:
  - i) losses for meters, pressure-reducing valves, backflow preventers, water treatment systems, and any other devices, and
  - ii) losses or gains due to changes in elevation.
- d) The number of fixture units (FU) as determined by using the sum of the total values given in Tables 2.6.3.2.-A, 2.6.3.2.-B, 2.6.3.2.-C and 2.6.3.2.-D.
- e) The maximum velocities permitted in accordance with the manufacturer’s recommendations for the pipe and fittings chosen for the installation.

Note that a private water supply system must be capable of meeting the demands of the water distribution system.

### Pipe Sizing Procedures (See Figure A-2.6.3.1.(2)-A.)

Step 1: Water Service Piping (See Table A-2.6.3.1.(2)-B.)

- a) Obtain the total fixture units required for the installation using the sum of the total values given in Tables 2.6.3.2.-A, 2.6.3.2.-B, 2.6.3.2.-C and 2.6.3.2.-D and consider all other demands on the water supply.



- b) Determine the minimum static pressure available at the property line or private water supply system and consider all pressure losses for the water service.
- c) Select the pressure range group in Table A-2.6.3.1.(2)-A that is consistent with the minimum static pressure available including any other losses.
- d) Select the length column in Table A-2.6.3.1.(2)-A that is equal to or greater than the developed length from the property line or private water supply system to the water service entry point to the building.
- e) In that column, find the fixture unit value that is equal to or greater than the fixture unit demand for the installation and follow the row back to the first column to locate the water service pipe size.
- f) To establish the adjusted static pressure available where the water service enters the building for sizing the water distribution system, subtract the actual static pressure losses for the water service from the minimum static pressure available at the property line.
- g) The adjusted static pressure available where a private water supply system is installed should be the static pressure available from such a system at the entry to the building.

Step 2: Hot Water Piping (See Table A-2.6.3.1.(2)-C.)

- a) Start with the most remote outlet in the most distant occupancy that requires hot water.
- b) Use the sum of the total fixture unit values given in Tables 2.6.3.2.-A, 2.6.3.2.-B, 2.6.3.2.-C and 2.6.3.2.-D and work back toward the service water heater, adding in the fixture unit values as they occur.
- c) Select the pressure range group in Table A-2.6.3.1.(2)-A that is consistent with the minimum static pressure available at the water service entry and any other losses (e.g. elevation or devices such as backflow preventers, etc.). Use this pressure range group for all portions (hot and cold) of the water distribution system.
- d) Select the length column that is equal to or greater than the developed length from the water service entry point to the building to the most remote outlet served with either hot or cold water.
- e) In that column, find the fixture unit value that is equal to or greater than the fixture unit demand at each pipe and follow the row back to the second column to locate the water distribution system pipe size.

Step 3: Cold Water Piping (See Table A-2.6.3.1.(2)-D.)

- a) Start with the most remote outlet on the cold water piping using the established total developed length column and pressure range group in Table A-2.6.3.1.(2)-A and work through Steps 2(c), (d) and (e) for hot water piping.
- b) Use the sum of the total fixture unit values given in Tables 2.6.3.2.-A, 2.6.3.2.-B, 2.6.3.2.-C and 2.6.3.2.-D and work back toward the water service entry.
- c) Where the service water heater distribution pipe occurs, add in the fixture unit demand of the fixtures served only with hot water and those that have not yet been added in as served to the cold water side of the most remote fixtures requiring both a hot and cold water supply.
- d) Continue by sizing the cold water main between the service water heater distribution pipe and the water service entry.
- e) Add in the fixtures served with cold water only from the main within the most remote occupancy as they occur and all common distribution piping serving hot and cold water to other occupancies as they occur.
- f) Complete by sizing all distribution piping served by the main within the most remote occupancy and then the other occupancies not yet sized using the previously established total developed length and pressure range group in Table A-2.6.3.1.(2)-A.

**Table A-2.6.3.1.(2)-A**  
**Pipe Sizes for Water Systems Based on Number of Fixture Units Served Using the Small Commercial Method<sup>(1)</sup>**

Water Service Pipe, inches	Water Distribution System, inches	Maximum Allowable Length, m														
		12	18	24	30	46	61	76	91	122	152	183	213	244	274	305
		Number of Fixture Units Served														
		Flow Velocity, m/s					3.0	2.4	1.5							
<b>Pressure Range 200 to 310 kPa</b>																
¾	½	6	5	4	3	2	1	1	1	0	0	0	0	0	0	0
¾	⅝	12	10	9	7	5	3	3	3	2	2	1	1	1	1	0
¾	¾	18	16	14	12	9	6	5	5	4	4	3	2	2	2	1
1	1	36	31	27	25	20	17	15	13	12	10	8	6	6	6	6
1½	1¼	83	68	57	48	38	32	28	25	21	18	15	12	12	11	11
1½	1½	151	124	105	91	70	57	49	45	36	31	26	23	21	20	20
2	1½	151	151	132	110	80	64	53	46	38	32	27	23	21	20	20
2	2	359	329	292	265	217	185	164	147	124	96	70	61	57	54	51
2½	2½	445	418	390	370	330	300	280	265	240	220	198	175	158	143	133
<b>Pressure Range 311 to 413 kPa</b>																
¾	½	8	7	6	5	4	3	2	2	1	1	1	0	0	0	0
¾	⅝	13	13	12	11	9	7	5	5	3	3	2	2	1	1	1
¾	¾	21	21	19	17	14	11	9	8	6	5	4	4	3	3	3
1	1	42	42	41	36	30	25	23	20	18	15	12	10	9	8	8
1½	1¼	83	83	83	83	66	52	44	39	33	29	24	20	19	17	16
1½	1½	151	151	151	151	128	105	90	78	62	52	42	38	35	32	30
2	1½	151	151	151	151	150	117	98	84	67	55	42	38	35	32	30
2	2	359	359	359	359	359	318	280	250	205	165	142	123	110	102	94
2½	2½	611	611	610	580	535	500	470	440	400	365	335	315	285	267	250
<b>Pressure Over 413 kPa</b>																
¾	½	8	8	7	6	5	4	3	3	2	1	1	1	1	1	0
¾	⅝	13	13	13	13	11	8	7	6	5	4	3	3	3	2	2
¾	¾	21	21	21	21	17	13	11	10	8	7	6	6	5	4	4
1	1	42	42	42	42	38	32	29	26	22	18	14	13	12	12	11
1½	1¼	83	83	83	83	83	74	62	54	43	34	26	25	23	22	21
1½	1½	151	151	151	151	151	151	130	113	88	73	51	51	46	43	40
2	1½	151	151	151	151	151	151	142	122	98	82	64	51	46	43	40
2	2	359	359	359	359	359	359	359	340	288	245	204	172	153	141	129
2½	2½	611	611	611	611	611	611	610	570	510	460	430	404	380	356	329

**Notes to Table A-2.6.3.1.(2)-A:**

- (1) Where total fixture unit values exceed those given in this Table, the system must be designed according to a detailed engineering design method.

**Table A-2.6.3.1.(2)-B**  
**Sizing of Water Service Pipe Using Figure A-2.6.3.1.(2)-A and Table A-2.6.3.1.(2)-A<sup>(1)</sup>**

Fixture Units	Pipe Size, inches
Total demand from Table A-2.6.3.1.(2)-E	210.8
Add in fixture units for fire sprinkler system, irrigation system and any other demands on water service	n/a in this example
Total demand in this example	2

**Notes to Table A-2.6.3.1.(2)-B:**

(1) Based on 30 m developed length and minimum static pressure at property line of 565 kPa.

**Table A-2.6.3.1.(2)-C**  
**Sizing of Hot Water System Using Figure A-2.6.3.1.(2)-A and Table A-2.6.3.1.(2)-A with Pressure Drop<sup>(1)</sup>**

Pipe Number	Fixture Units	Pipe Size, inches
1	8	¾
2	11	¾
3	15	1
4	6	¾
5	21	1
Total Fixture Units	21	1

**Notes to Table A-2.6.3.1.(2)-C:**

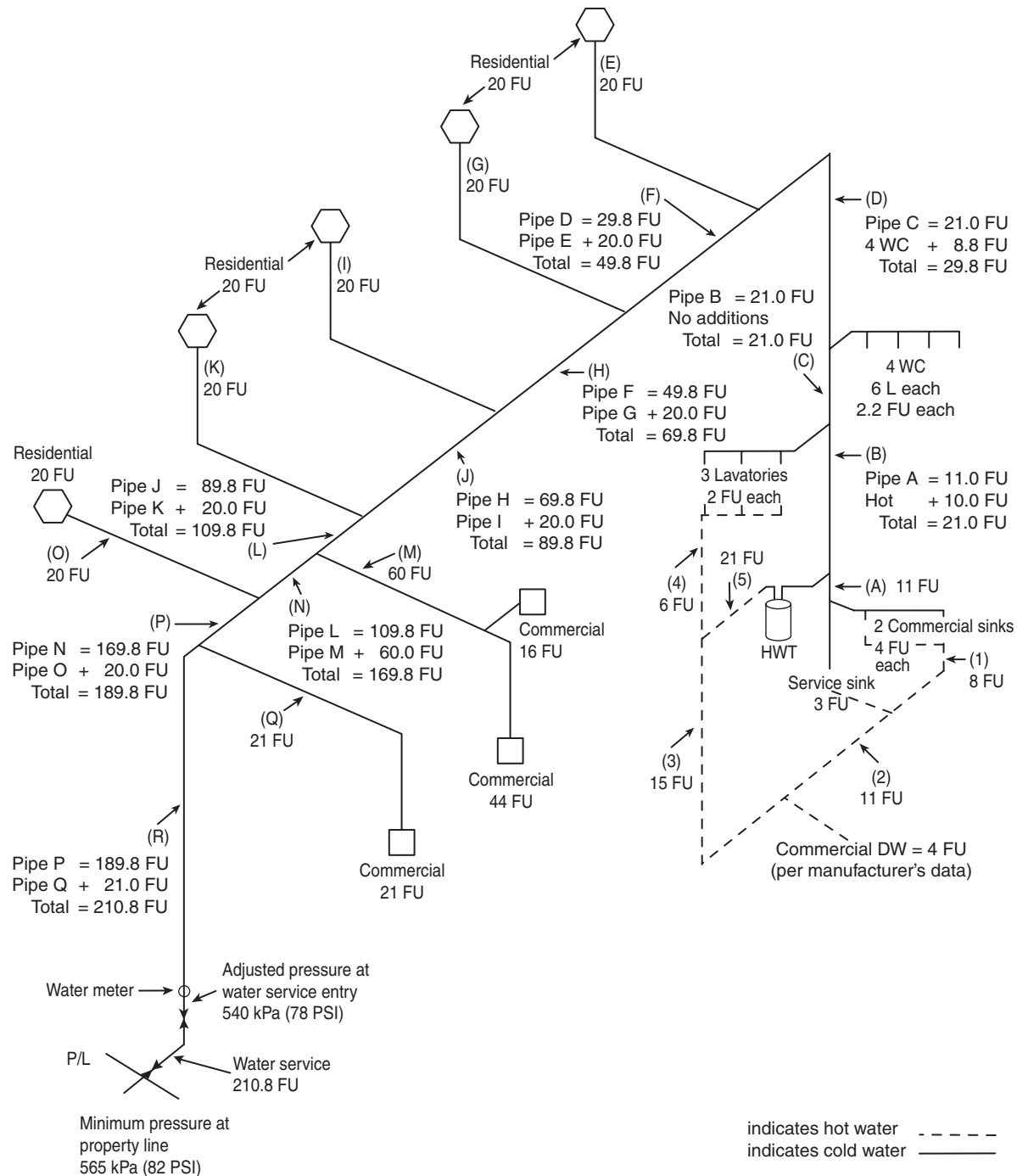
(1) Based on 76 m developed length and adjusted static pressure at building entry of 540 kPa.

**Table A-2.6.3.1.(2)-D**  
**Sizing of Cold Water System Using Figure A-2.6.3.1.(2)-A and Table A-2.6.3.1.(2)-A<sup>(1)</sup>**

Pipe Letter	Cold Water, fixture units	Pipe Size, inches
A	11	¾
B	21	1
C	21	1
D	29.8	1¼
E	20	1
F	49.8	1¼
G	20	1
H	69.8	1½
I	20	1
J	89.8	1½
K	20	1
L	109.8	1½
M	60	1¼
N	169.8	2
O	20	1
P	189.8	2
Q	21	1
R	210.8	2
Total Fixture Units	210.8	2

**Notes to Table A-2.6.3.1.(2)-D:**

(1) Based on 76 m developed length and minimum adjusted static pressure at building entry of 540 kPa.



For use with Small Commercial Buildings and Average Pressure Loss Methods of water pipe sizing

EG00672A

**Figure A-2.6.3.1.(2)-A**  
**Example of Commercial and Residential Development to be Used with Water Pipe Sizing Methods**

**Notes to Figure A-2.6.3.1.(2)-A:**

- (1) This example is a development with 4 commercial occupancies on the lower floor and 5 residential occupancies on the upper floor, all with separate service water heaters.
- (2) For the purpose of water pipe sizing:
  - the minimum adjusted pressure available at building entry is 540 kPa (78 PSI);
  - the developed length of the water service is 30 m (98 ft); and
  - the developed length of the water distribution system is 76 m (249 ft).

**Table A-2.6.3.1.(2)-E**  
**Fixture Units Summary for Figure A-2.6.3.1.(2)-A Using Tables 2.6.3.2.-A, -B, -C and -D**

Fixtures	Quantity	100% Fixture Unit Values	Total Demand (Quantity x Fixture Unit Values)
Lavatory, 8.3 LPM or less	3	2	6
Commercial sink	2	4	8
Service sink	1	3	3
W.C., 6 LPF or less	4	2.2	8.8
Other	–	–	–
Commercial dishwasher	1	4	4
Commercial occupancy	1	16	16
Commercial occupancy	1	44	44
Commercial occupancy	1	21	21
Residential occupancy	5	20	100
		Total Fixture Units	210.8

### Average Pressure Loss Method

Information required if using this method:

- a) The developed length:
  - i) from the property line or private water system when located outside the building to the water service entry point to the building, and
  - ii) from the building entry of the water service to the most remote water outlet.
- b) Minimum static pressure:
  - i) the minimum static pressure available at the property line or other water source (private water supply system), or
  - ii) where there is a wide fluctuation of pressure in the main throughout the day, the minimum static pressure available.
- c) Pressure losses:
  - i) losses for meters, pressure-reducing valves, backflow preventers, water treatment systems, and any other devices, and
  - ii) losses or gains due to changes in elevation.
- d) The number of fixture units as determined by using the sum of the total values given in Tables 2.6.3.2.-A, 2.6.3.2.-B, 2.6.3.2.-C and 2.6.3.2.-D.
- e) The maximum velocities permitted in accordance with the manufacturer's recommendations for the pipe and fittings chosen for the installation.

Note: The private water supply system must be capable of meeting the demands of the water distribution system.

To use this method, calculate the pressure available for friction loss which must be 2.6 kPa per metre or more; if it is less than that, the system must be designed according to a detailed engineering design method.

### Calculating Pressure Available for Friction Loss (See Figure A-2.6.3.1.(2)-B.)

- a) Obtain the water service size, including pressure losses, and the design of the private water supply system if it is separate from the water distribution system.
- b) To calculate the total equivalent length for the water distribution system, determine the developed length from the water service entry point to the building to the most remote water outlet, and
  - i) where fitting inside diameter dimensions are at least equal to the pipe size, multiply the developed length by 1.5 to allow for friction losses, and
  - ii) where insert fittings are used, apply additional losses in accordance with the fitting manufacturer's data.

- c) To determine the adjusted pressure available at the water service entry for sizing the water distribution system, deduct the pressure losses for the water service from the minimum static pressure available at the property line or private water source.
- d) To obtain the pressure available for friction loss, use the minimum adjusted static pressure available at the water service entry and deduct the minimum operating pressure necessary at the most remote water outlet, and losses for meters, pressure-reducing valves, backflow preventers, water treatment systems, and any other devices. Include pressure losses or gains due to changes in elevation between the water service entry and the most remote water outlet.
- e) Divide the static pressure available for friction loss by the total equivalent length to obtain the pressure available for friction loss per metre.

**Step 1(c)**

565 kPa	–	25 kPa	=	540 kPa
Minimum static pressure		Pressure losses for service		Adjusted pressure at water service entry to the building

**Step 1(d)**

540 kPa	–	20 kPa	+	35 kPa	+	105 kPa	)	=	380 kPa
Adjusted pressure		Meter, PRV, BFP and other losses		Losses for system height		Minimum pressure necessary at the fixture for operation			Total pressure available for friction loss from the water service entry to the most remote water supply outlet

**Step 1(e)**

380 kPa	÷	114 m	=	3.3 kPa per metre
Total pressure available for friction loss		Developed length x 1.5 for fittings and/or additional losses if insert fittings are used		Average pressure loss must be minimum 2.6 kPa per metre

EG00673A

**Figure A-2.6.3.1.(2)-B**  
**Determination of Pressure Available for Friction Loss**

### Pipe Sizing Procedures (See Figure A-2.6.3.1.(2)-A)

Step 1: Water Service Piping (See Table A-2.6.3.1.(2)-G)

- a) Obtain the total fixture units required for the installation using the sum of the total values given in Tables 2.6.3.2.-A, 2.6.3.2.-B, 2.6.3.2.-C and 2.6.3.2.-D and consider all other demands on the water supply.
- b) Select the water service pipe size from Table A-2.6.3.1.(2)-F using the velocity column that is consistent with the pipe and fittings chosen for the installation.
- c) Determine the minimum static pressure available at the property line or private water source and consider all pressure losses for the water service.
- d) To establish the adjusted static pressure available where the water service enters the building for sizing the water distribution system, subtract the actual static pressure losses for the water service from the minimum static pressure available at the property line.
- e) The adjusted static pressure available where a private water supply system is installed should be the static pressure available from such a system at the entry to the building.

Step 2: Hot Water Piping (See Table A-2.6.3.1.(2)-H)

- a) Start with the most remote outlet in the most distant occupancy that requires hot water.
- b) Use the sum of the total fixture unit values given in Tables 2.6.3.2.-A, 2.6.3.2.-B, 2.6.3.2.-C and 2.6.3.2.-D and work back toward the service water heater, adding in the fixture unit values as they occur.

- c) Size the hot water system according to Table A-2.6.3.1.(2)-F using the velocity column that is consistent with the manufacturer's requirements for the pipe and fittings chosen when serving a hot water system.

Step 3: Cold Water Piping (See Table A-2.6.3.1.(2)-I)

- a) Start with the most remote outlet requiring cold water in the most distant occupancy and working back towards the water service entry adding in the fixture unit values as they occur.
- b) Obtain the fixture units using the sum of the total fixture unit values given in Tables 2.6.3.2.-A, 2.6.3.2.-B, 2.6.3.2.-C and 2.6.3.2.-D.
- c) Size the cold water system to Table A-2.6.3.1.(2)-F using the velocity column that is consistent with the manufacturer's requirements for the pipe and fittings chosen when serving a cold water system.
- d) Where the service water heater distribution pipe occurs, add in the fixture unit demand of the fixtures served with only hot water and those that have not yet been added in as served to the cold water side of the most remote fixtures requiring both hot and cold water supply.
- e) Continue by sizing the cold water main between the service water heater distribution pipe and the water service entry.
- f) Add in the fixtures served with only cold water from the main within the most remote occupancy as they occur and then all common distribution piping serving hot and cold water to other occupancies as they occur.
- g) Complete by sizing all distribution piping served by the main in the most remote occupancy and then the other occupancies not yet sized using Table A-2.6.3.1.(2)-F.

**Table A-2.6.3.1.(2)-F  
Pipe Sizes for Water Systems Based on Number of Fixture Units Served Using the Average Pressure Loss Method**

Pipe Size, inches	Water Velocity							
	3.0 m/s (10 ft/s)		2.4 m/s (8 ft/s)		1.5 m/s (5 ft/s)		1.2 m/s (4 ft/s)	
	Flow and Fixture Units Served							
	L/s	Fixture Units	L/s	Fixture Units	L/s	Fixture Units	L/s	Fixture Units
½	0.46	8	0.36	7	0.23	3.5	0.18	2.5
⅝	0.68	13	0.54	11	0.34	6.5	0.27	4.5
¾	0.95	21	0.77	17	0.48	9	0.38	7.5
1	1.62	42	1.26	30	0.81	18	0.65	14
1¼	2.47	83	1.8	54	1.24	29	0.99	22
1½	3.5	146	2.8	102	1.75	46	1.4	34
2	6.08	337	4.92	265	3.04	120	2.43	81
2½	9.39	692	7.89	500	4.69	245	3.75	170
3	13.23	1 018	10.73	750	6.7	400	5.36	295
4	23.94	2 480	18.9	1 800	11.78	850	9.42	600
5	37	4 400	29	3 350	18.35	1 625	14.68	1 125
6	52.1	6 600	42	4 800	26.38	2 875	21.11	2 125

**Table A-2.6.3.1.(2)-G**  
**Sizing of Water Service Pipe Using Figure A-2.6.3.1.(2)-A and Table A-2.6.3.1.(2)-F<sup>(1)</sup>**

Fixture Units	Pipe Size, inches
Total demand from Table A-2.6.3.1.(2)-E	210.8
Add in fixture units for fire sprinkler system, irrigation system and any other demands on water service	n/a in this example
Total demand in this example	2

**Notes to Table A-2.6.3.1.(2)-G:**

(1) Based on 30 m developed length and minimum static pressure at property line of 565 kPa.

**Table A-2.6.3.1.(2)-H**  
**Sizing of Hot Water System Using Figure A-2.6.3.1.(2)-A and Table A-2.6.3.1.(2)-F with Flow Velocity<sup>(1)</sup>**

Pipe Number	Fixture Units	Pipe Size, inches
1	8	¾
2	11	1
3	15	1
4	6	⅝
5	21	1¼
Total Fixture Units	21	1¼

**Notes to Table A-2.6.3.1.(2)-H:**

(1) Based on 1.5 m/s and adjusted static pressure at building entry of 540 kPa.

**Table A-2.6.3.1.(2)-I**  
**Sizing of Cold Water System Using Figure A-2.6.3.1.(2)-A and Table A-2.6.3.1.(2)-F<sup>(1)</sup>**

Pipe Letter	Cold Water, fixture units	Pipe Size, inches
A	11	⅝
B	21	1
C	21	1
D	29.8	1
E	20	1
F	49.8	1¼
G	20	1
H	69.8	1½
I	20	1
J	89.8	1½
K	20	1
L	109.8	2
M	60	1½
N	169.8	2
O	20	1
P	189.8	2
Q	21	1
R	210.8	2
Total Fixture Units	210.8	2

**Notes to Table A-2.6.3.1.(2)-I:**

(1) Based on 2.4 m/s velocity and adjusted static pressure at water service entry of 540 kPa.



**A-2.6.3.2.(4) Sizing for Flush Valves.** Distribution piping and water mains serving flush valves may be sized using the values assigned in Tables 2.6.3.2.-B and 2.6.3.2.-C, beginning with the most remote flush valve on each section of distribution piping served by the water main.

**A-2.6.3.4.(5) Sizing of Water Systems.** Sentence 2.6.3.4.(5) and Table 2.6.3.4. present a simplified method of water system sizing, which is permitted in buildings containing one or two dwelling units or row houses with separate water services.

### Simplified Method

This sizing method may be used in the buildings noted, where:

- a) the total developed length from the property line to the most remote fixture is not more than 90 m, and
- b) the static pressure available at the water service entry to the building is not less than 200 kPa.

Where either the developed length is exceeded or the minimum static pressure required is not known, a detailed engineering design method must be used to size the water service piping. The design must ensure a minimum static pressure of 200 kPa is available at the water service entry to the building.

Information required when using this method:

- a) The total number of fixture units (FU) as determined by using the sum of the total fixture unit values given in Tables 2.6.3.2.-A, 2.6.3.2.-B, 2.6.3.2.-C and 2.6.3.2.-D.
- b) Where the water service also serves a fire sprinkler system, irrigation system, or any other system, these demands must be added to the water service sizing.

### Pipe Sizing Procedures

#### Step 1: Water Service Pipe

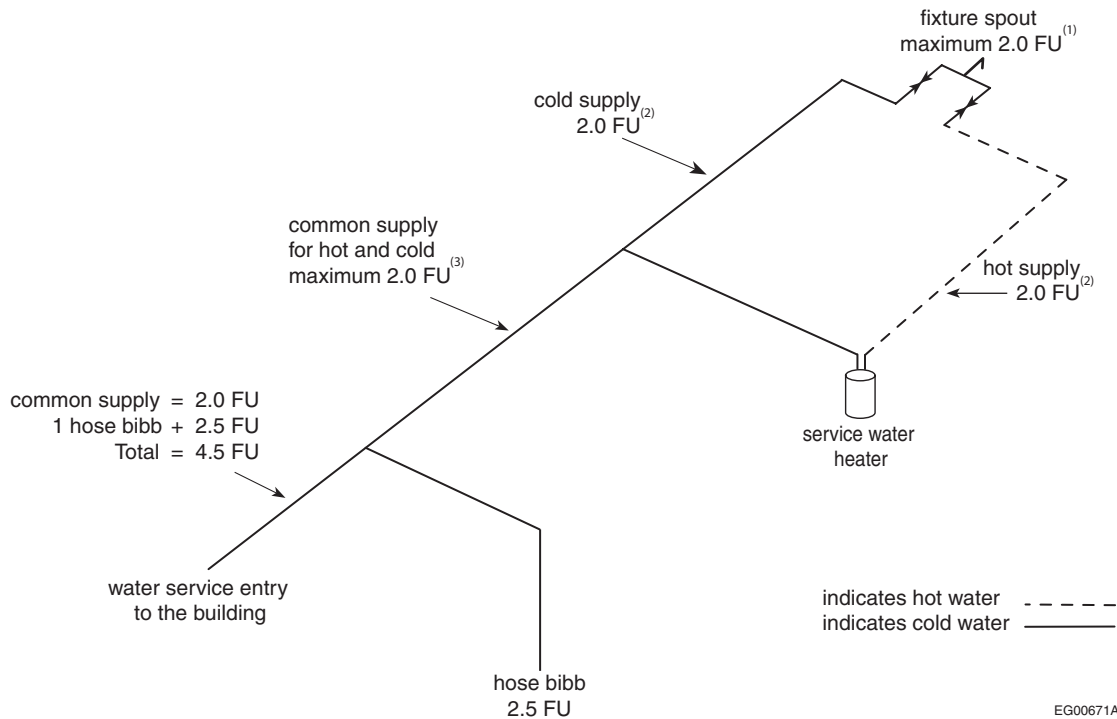
- a) Obtain the total fixture units required for the installation using the sum of the total values given in Tables 2.6.3.2.-A, 2.6.3.2.-B, 2.6.3.2.-C and 2.6.3.2.-D and consider all other demands on the water supply.
- b) Determine the water service pipe size using the water velocity column in Table 2.6.3.4. that is consistent with the pipe material chosen for the installation.

#### Step 2: Hot Water Piping

- a) Start with the most remote fixture requiring a supply of hot water and work back toward the service water heater, adding in the fixture unit loads as they occur.
- b) Determine the fixture units using the sum of the total fixture unit values given in Tables 2.6.3.2.-A, 2.6.3.2.-B, 2.6.3.2.-C and 2.6.3.2.-D.
- c) Size the hot water system using the water velocity column in Table 2.6.3.4. that is consistent with the manufacturer's recommendations for the pipe and fittings chosen when serving a hot water system.

#### Step 3: Cold Water Piping

- a) Start with the most remote fixture requiring a supply of cold water and work back toward the water service entry, adding in the fixture unit loads as they occur.
- b) Obtain the fixture units using the sum of the total fixture unit values given in Tables 2.6.3.2.-A, 2.6.3.2.-B, 2.6.3.2.-C and 2.6.3.2.-D.
- c) Size the cold water system using the water velocity column in Table 2.6.3.4. that is consistent with the manufacturer's recommendations for the pipe chosen when serving a cold water system.
- d) Where the service water heater distribution pipe occurs, add in the fixture unit demand of the fixtures served with only hot water and those that have not yet been added in as served to the cold water side of the fixtures requiring both a hot and cold water supply.
- e) Continue sizing the cold water main between the service water heater distribution pipe and the water service entry by adding all fixtures served with only a cold water supply as they occur.
- f) Complete by sizing all cold water distribution piping served by the main between the water heater distribution pipe and the water service entry.



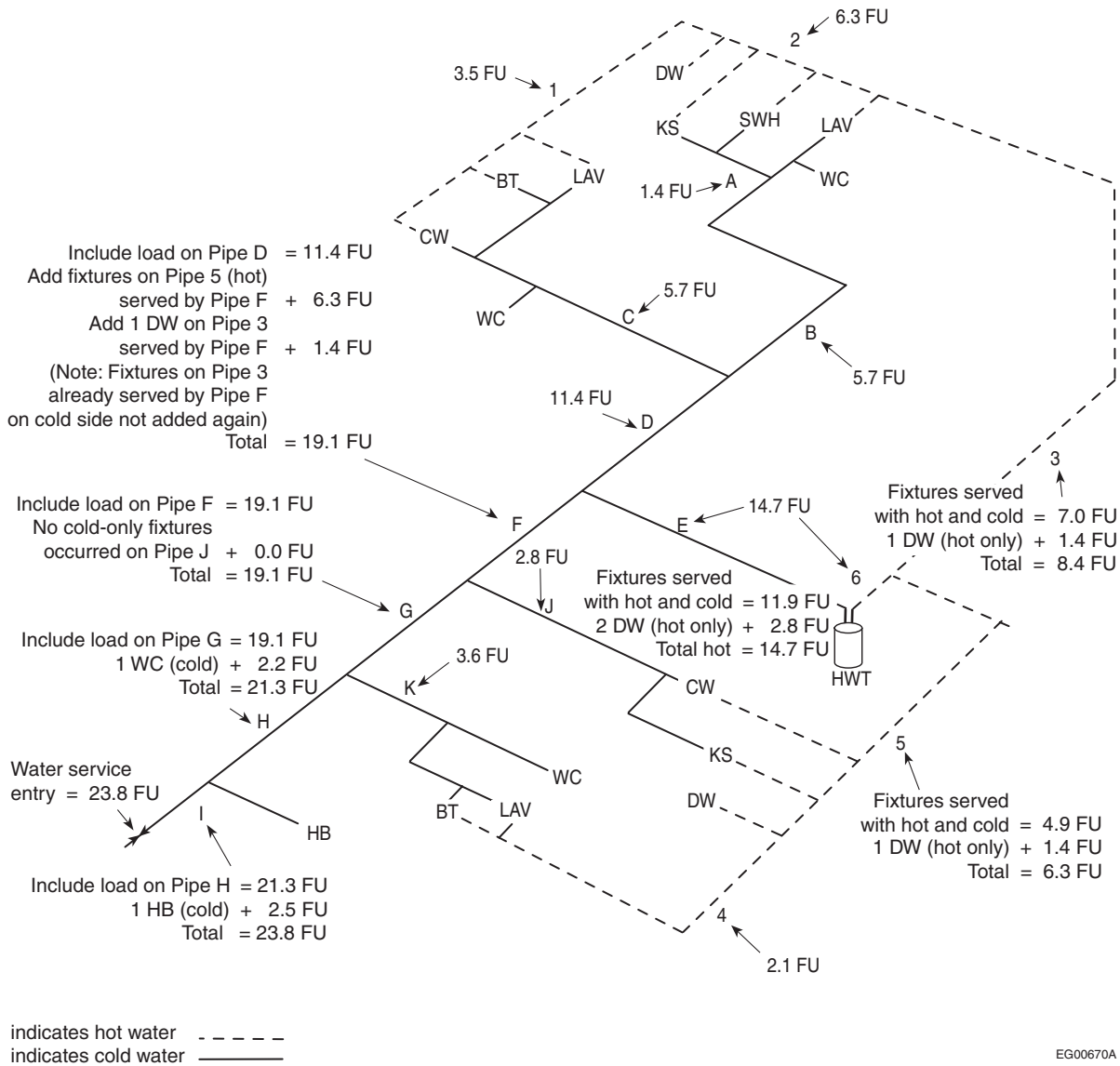
**Figure A-2.6.3.4.(5)-A**  
**Determining the hydraulic needs of a fixture**

**Notes to Figure A-2.6.3.4.(5)-A:**

- (1) The fixture spout delivers a maximum of 2.0 fixture units.
- (2) This would apply if only the hot side or the cold side were fully opened.
- (3) The common pipe that serves both the hot and cold sides of the faucet also delivers a maximum of 2.0 fixture units even if both the hot and cold valves at the faucet are fully opened at the same time.

**Table A-2.6.3.4.(5)-A**  
**Fixture Units Summary Using Figure A-2.6.3.4.(5)-B and Tables 2.6.3.2.-A, -B, -C and -D**

Fixtures	Number of Fixtures	100% Fixture Unit Values	Total Demand (Quantity x Fixture Unit Values)
Bathtub	2	1.4	2.8
Clothes washer	2	1.4	2.8
Dishwasher	2	1.4	2.8
Hose bibb	1	2.5	2.5
Lavatory, 8.3 LPM or less	3	0.7	2.1
Shower, 9.5 LPM or less	1	1.4	1.4
Sink, 8.3 LPM or less	2	1.4	2.8
W.C., 6 LPF or less	3	2.2	6.6
Other			
<b>Total Fixture Units</b>			<b>23.8</b>



**Figure A-2.6.3.4.(5)-B**  
 Example of water pipe sizing for buildings containing one or two dwelling units or row houses with separate water services

**Table A-2.6.3.4.(5)-B**  
 Sizing of Water Service Pipe Using Figure A-2.6.3.4.(5)-B and Table 2.6.3.4.

Fixture Units		Water Velocity, m/s		
		3.0	2.4	1.5
		Pipe Size, inches		
Total fixture units	23.8	–	–	–
Fire sprinkler system	n/a	–	–	–
Irrigation system	n/a	–	–	–
Other	n/a	–	–	–
Total demand on water service	23.8	1	1	1¼

**Table A-2.6.3.4.(5)-C**  
**Sizing of Hot Water System Using Figure A-2.6.3.4.(5)-B and Table 2.6.3.4.**

Pipe Number	Hot Water Fixture Units	Water Velocity, m/s		
		3.0	2.4	1.5
		Pipe Size, inches		
1	3.5	½	½	½
2	6.3	½	½	¾
3	8.4	¾	¾	¾
4	2.1	½	½	½
5	6.3	½	½	¾
6	14.7	¾	¾	1
Total Fixture Units	14.7			

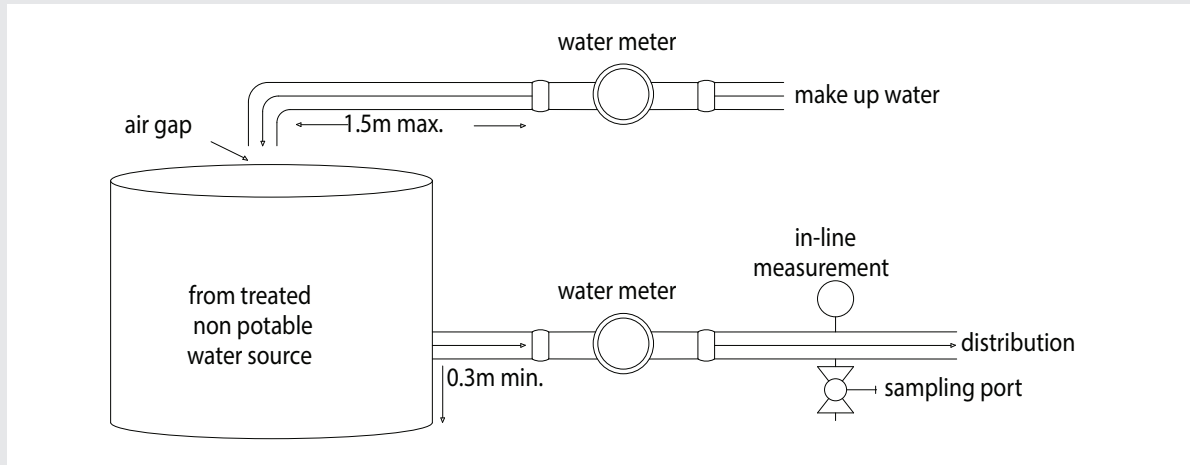
**Table A-2.6.3.4.(5)-D**  
**Sizing of Cold Water System Using Figure A-2.6.3.4.(5)-B and Table 2.6.3.4.**

Pipe Letter	Cold Water Fixture Units	Water Velocity, m/s		
		3.0	2.4	1.5
		Pipe Size, inches		
A	2.8	½	½	½
B	5.7	½	½	¾
C	5.7	½	½	¾
D	11.4	¾	¾	1
E	14.7	¾	¾	1
F	19.1	¾	1	1¼
G	19.1	¾	1	1¼
H	21.3	1	1	1¼
I	23.8	1	1	1¼
J	2.8	½	½	½
K	3.6	½	½	½
Total Fixture Units	23.8			

**A-2.7.3.2.(1) Outlets from Non-Potable Water Systems.** The location of outlets from non-potable water systems where they can be discharged into a sink or lavatory, a fixture into which an outlet from a potable water system is discharged, or a fixture that is used for the preparation, handling or dispensing of food, drink or products that are intended for human consumption, may have proven acceptable on the basis of past performance in some localities, and its acceptance under this Code may be warranted.

Subclause 2.7.3.2.(1)(b) would permit non-potable water to be used to supply water closets or urinals provided the fixtures are not also connected to potable water.

**A-2.7.6.4, 2.7.6.5. and 2.7.6.6. Non-potable Water System Design**



**Figure A-2.7.6.4., 2.7.6.5. and 2.7.6.6.**  
Schematic Example for a Non-potable Water System